



BBZ, Vilshofen

Price List

2023 / 2024

INTERNATIONAL

alwitra offers with its flat roof systems EVALON® and EVALASTIC® two technically and technologically adapted and worldwide well-proven product lines for intelligent roof details including all connections and penetrations that resist reliably and durably to all effects and loads of the waterproofing.

All products of this flat roof system are easy and quick to install. They allow a maximum design flexibility and are very economical by their durability.

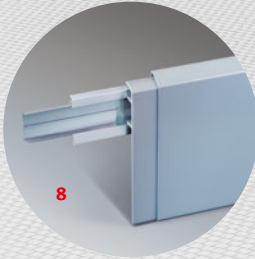

Table of Contents

Table of Contents

| | | |
|---|---|---------|
| | flat roof system | 4-5 |
| Product range | Products | |
| WATERPROOFING MEMBRANES | EVALON® | 6-15 |
| | EVALASTIC® | 16-21 |
| ROOF EDGE TRIM PROFILES | T plus, TW 125 plus | 22-25 |
| | TA | 26-27 |
| | TA-4F | 28-29 |
| | TAG 250 – 400 | 30-31 |
| | TAG 450 – 1050 | 32-33 |
| | art-line 1 | 34-35 |
| WALL CAPPING PROFILES | MAG-4 (available ex stock) | 36-39 |
| | MAG-4 | 40-41 |
| | MAG-6 | 42-43 |
| | MAG-5 | 44-45 |
| WALL FLASHING PROFILES | WA 1 | 46-49 |
| | WA 150 | 50-51 |
| | WA 1 - ÜK | 52-53 |
| COLOUR COATING | alwitra colour world for aluminium profiles | 54-59 |
| DAYLIGHT SYSTEMS | Rooflights..... | 60-65 |
| | Fall-through protection grating | 66 |
| | DayLuxe window 2.0..... | 67 |
| | Accessories Daylight systems | 68-69 |
| | NRA Type 24 (smoke vent system) | 70-71 |
| EVASTEEL  | EVASTEEL | 72-75 |
| | Rainwater outlets | 76-79 |
| | Vent stack | 80-81 |
| | Penetrations | 82-83 |
| FLAT ROOF DRAINAGE | Rainwater outlets | 84-88 |
| | Emergency outlets | 89 |
| | Refurbishment rainwater outlet | 90 |
| | Water spouts (emergency outlets) | 91-93 |
| | Accessories and spare parts rainwater outlets / emergency outlets | 94-97 |
| FLAT ROOF VENTS | Vents and accessories | 98-101 |
| PAVING SLAB SUPPORTS | Type PA 20 plus | 102-104 |
| | Shim | 105-107 |
| Information | | |
| | Packing units | 108-111 |
| | Information and additional delivery conditions | 112 |

The unique alwitra flat roof system.



One-stop solutions from roof edge to roof edge.



- 1 Roof edge trim profiles
- 2 Daylight systems
- 3 Flat roof vents
- 4 Waterproofing membranes
- 5 Rainwater outlets
- 6 Paving slab supports
- 7 Wall capping profiles
- 8 Wall flashing profiles

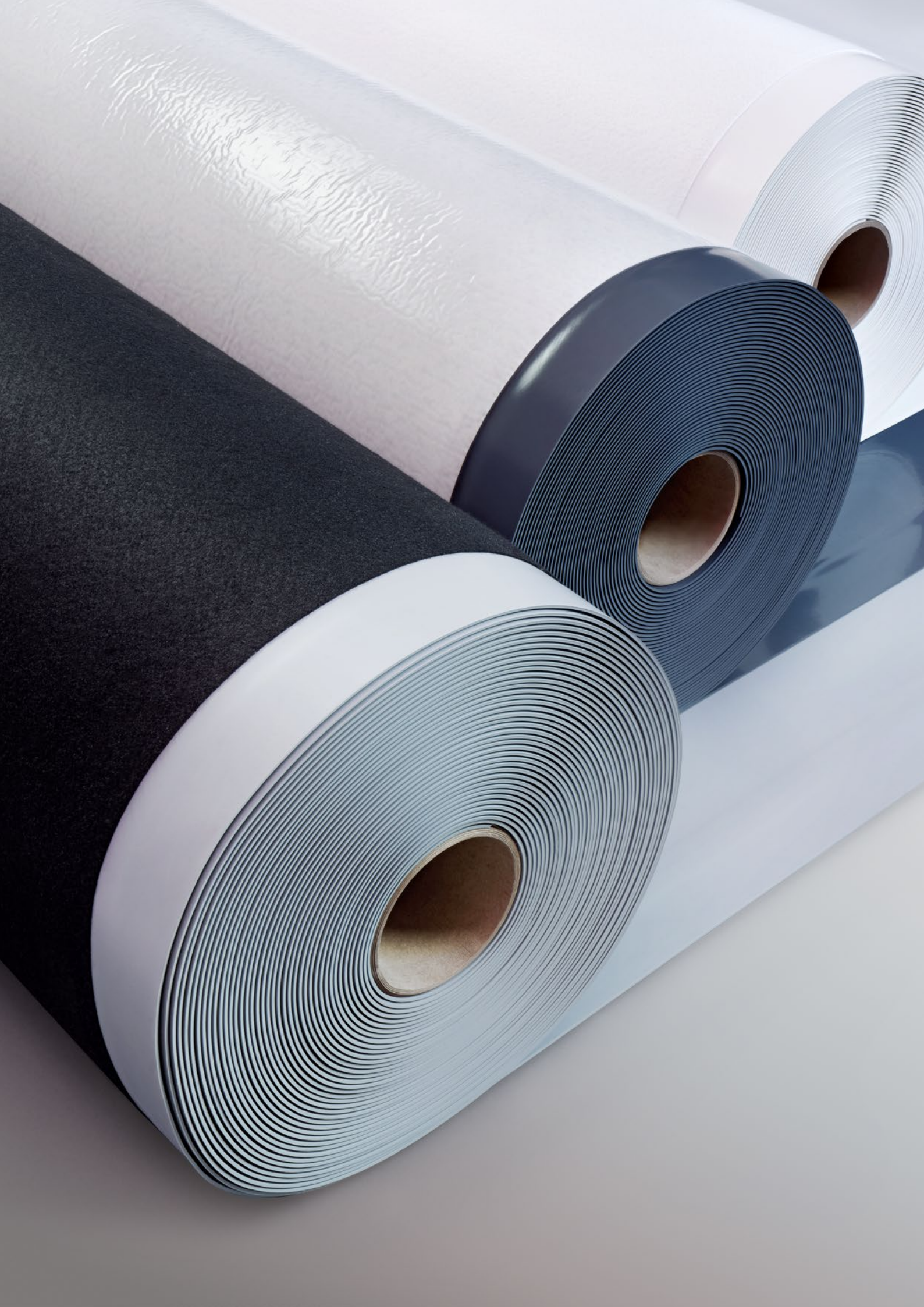

Waterproofing membranes

EVALON® EVA waterproofing membranes

| | Product | Product specification | Dimension (m) Length ¹ x Width | Colour | Thick- ness | €/m ² |
|---|---------------------|---|--|--|----------------|------------------|
|  | EVALON® V | homogeneous sealing layer, with polyester fleece backing | 25 x 1.05 (1.09) ² 25 x 1.55 (1.59) ² 25 x 2.05 ³ | white/ light grey/ slate grey | 1.2 mm | 26.75 |
| | | | | | 1.5 mm | 31.55 |
|  | EVALON® VG | homogeneous sealing layer, with glass fleece / polyester fleece backing | 25 x 1.05 (1.09) ² 25 x 1.55 (1.59) ² | white/ light grey/ slate grey | 1.5 mm | 32.15 |
| | | | 25 x 1.05 | green/ brick red | 1.5 mm | 35.05 |
|  | EVALON® VSK | homogeneous sealing layer, with polyester fleece backing and self-adhesive coating | 25 ⁴ x 1.05 | light grey/ slate grey | 1.2 mm | 31.05 |
| | | | | white on request | 1.5 mm | 35.80 |
|  | EVALON® VGSK | homogeneous sealing layer, with glass fleece / polyester fleece backing and self-adhesive coating | 25 ⁴ x 1.05 | light grey/ slate grey white on request | 1.5 mm | 37.10 |

¹ Surcharge for special lengths (at least 15 m) on request

³ Membrane width 2.05 m only available in light grey/slate grey, white on request

² with double selvedge

⁴ up to 5% short length quota





EVALON® tapes (standard length 25 m)

| Tape width | EVALON® | | | | | EVALON® V | | EVALON® VG | EVALON® VSKA |
|------------|------------------------------|------------------|------------------|------------------------------|--------|--|--------|--|--|
| | homogeneous | | | | | homogeneous sealing layer, with polyester fleece backing | | homogeneous sealing layer, with polyester fleece /glass fleece backing | homogeneous sealing layer, with polyester fleece backing and self-adhesive coating |
| | white/light grey/ slate grey | green/ brick red | | white/light grey/ slate grey | | white/light grey/ slate grey | | white/light grey/ slate grey | light grey/slate grey, white on request |
| | €/m | €/m | €/m ² | €/m ² | | €/m | | €/m | €/m |
| | 1.5 mm | 1.5 mm | 1.5 mm | 1.2 mm | 1.5 mm | 1.2 mm | 1.5 mm | 1.5 mm | 1.5 mm |
| 16 cm | 5.05 | 5.45 | - | - | - | - | - | - | - |
| 20 cm | 6.20 | 6.70 | - | - | - | - | - | - | - |
| 25 cm | 7.55 | 8.25 | - | - | - | - | - | - | - |
| 33 cm | 9.80 | 10.75 | - | - | - | - | - | - | 12.25 ¹ |
| 43 cm | - | - | - | - | - | - | - | - | 15.85 ¹ |
| 50 cm | 14.65 | 16.00 | - | - | - | - | - | - | - |
| 54 cm | - | - | - | - | - | 14.95 | 17.50 | 17.85 | - |
| 63 cm | - | - | - | - | - | - | - | - | 23.05 ¹ |
| 66 cm | 19.15 | 21.05 | - | - | - | - | - | - | 24.15 ² |
| 75 cm | 21.65 | 23.80 | - | - | - | - | - | - | - |
| 79 cm | - | - | - | - | - | 21.55 | 25.45 | 25.95 | - |
| 86 cm | - | - | - | - | - | - | - | - | 31.30 ² |
| 105 cm | - | - | 31.20 | 23.55 | 28.25 | - | - | - | - |
| 155 cm | - | - | - | 23.55 | 28.25 | - | - | - | - |
| 126 cm | - | - | - | - | - | - | - | - | 45.20 ² |



¹ with single selvedge (approx. 12.5 cm wide)

² with double selvedge (each approx. 12.5 cm wide)



Adhesives / cleaner

| | Product | Quantity | Packing unit/pallet | €/packing unit | €/tin |
|---|---|-----------------|--|--|--------------------------------|
|  | alwitra adhesive L 40 | 25 kg 9.5 kg | 12 containers 30 containers | 20.25 €/kg 21.80 €/kg | 506.25 207.10 |
|  | alwitra adhesive PUR S750 | 750 ml | 12 tins only full packing units at 12 tins/carton | 51.00 €/l | 38.25 |
|  | alwitra foam gun with 60 cm lance | | | 101.75 €/piece | |
|  | alwitra membrane cleaner not suitable for cleaning of the seam area! | 2 kg | | 23.70 €/kg | 47.40 |
|  | alwitra cleaner L 40 (tool cleaner) | 10 l | | 15.65 €/l | 156.50 |

Primer

| | Product | Quantity | Packing unit/pallet | €/l | €/tin |
|---|--|--------------|--------------------------------------|------------------------------|--------------------------------|
|  | alwitra primer SK-L Solvent-based dispersion for pre-treatment of various substrates for bonding alwitra self-adhesive membranes EVALON® VSK, EVALON® VGSK and EVALON® VSKA. | 25 l 10 l | 12 pieces 42 pieces | 21.15 22.10 | 528.75 221.00 |
|  | alwitra primer SK Solvent-free dispersion for pre-treatment of various substrates for bonding alwitra self-adhesive membranes EVALON® VSK, EVALON® VGSK and EVALON® VSKA. | 25 l 10 l | 12 pieces 44 pieces | 19.40 20.35 | 485.00 203.50 |

Solvent welding agent / liquid EVALON®

| | Product | Quantity | Packing unit/pallet | €/l | €/tin |
|---|--|----------|---------------------|--------------|---------------|
|  | alwitra solvent welding agent for seam welding of EVALON® membranes and for seam preparation of weathered resp. soiled alwitra waterproofing membranes | 3.0 l | 12 pieces | 42.80 | 128.40 |
|  | liquid EVALON® white/light grey/slate grey | 2.5 l | 4 pieces | 52.25 | 130.60 |

EVALON® maintenance walkway tile¹

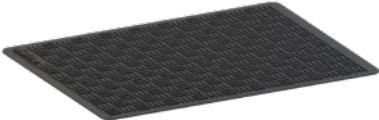
| | Product data | Packing unit | €/tile |
|---|---|--|--------------|
|  | Length x Width: approx. 800 x 600 mm Area: 0.48 m ² Surface: structured, bar height approx. 4 mm Total thickness: approx. 8.5 mm Colour: dark grey | pallet at 200 plates or bundle at 5 tiles (minimum quantity: 1 bundle, complete units only) | 31.70 |

¹ Installation on EVALON® membranes only by gluing with EVATAK

EVATAK glue and sealant cartridge, one component

| | Product data | €/cartouche |
|---|---|--------------|
|  | Volume: 290 ml / cartouche Consumption: approx. 90-100 ml/maintenance walkway tile Packaging unit: 24 pieces/carton | 23.45 |

EVALON® standing seam effect profile ¹





| | Product data | Colour | €/m |
|---|---------------|---|-------------|
|  | Length: 2.0 m | light grey/slate grey (other colours on request) | 7.95 |
| | | green (other colours on request) | 8.35 |

¹ Joint connections included

alwitra solvent welding machine

| | Product specification | Price |
|---|--------------------------------|-------------------|
|  | solvent welding machine mobile | on request |

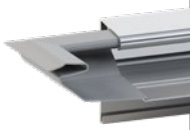
EVALON® prefabricated parts

| | Product | Product specification | Colour | Ø internal | €/piece |
|---|------------------------|--|--|------------|--------------|
|  | Internal corner | for parapets | white/light grey/slate grey, other colours on request | | 8.65 |
|  | External corner | for parapets | white/light grey/slate grey, other colours on request | | 8.65 |
|  | Internal corner | for roof edge trim profiles | white/light grey/slate grey, other colours on request | | 11.60 |
|  | External corner | for roof edge trim profiles | white/light grey/slate grey, other colours on request | | 11.60 |
|  | Sleeve | for penetrations incl. heat shrink tube | white/light grey/slate grey, other colours on request | Ø 50 mm | 75.10 |
| | | | | Ø 80 mm | 81.40 |
| | | | | Ø 110 mm | 91.70 |
|  | Sleeve | for flash protection and cable penetration/ fall protection incl. heat shrink tube | white/light grey/slate grey, other colours on request | Ø 18 mm | 32.55 |
| | | | | Ø 26 mm | 36.65 |

Snow guard profile

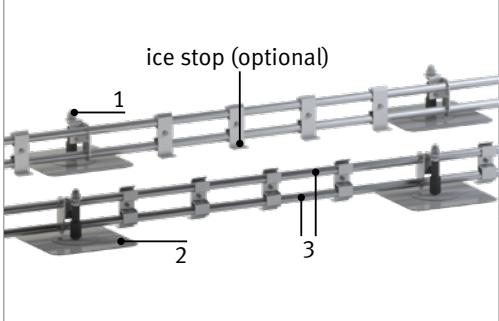
| Scope of delivery | Price |
|---|-------------------|
|  <p>ice stop (optional)</p> <p>1</p> <p>2</p> <p>3</p> | on request |
| <p>1 Stainless steel pillar with retaining clip¹ with fasteners</p> | |
| <p>2 EVALON® prefabricated part with self-adhesive shrink tube and collar</p> | |
| <p>3 Stainless steel catching pipes, 26.9 x 2 mm, 6.00 m (5.94 m) with plug-in system</p> | |

¹ Pillar distance: calculation according to snow load area and roof geometry

alwitra stainless steel terrace profile

joint width depending on profile length and installation temperature

| | | | | | |
|--|--|--------|--------|--------|--------|
|  | <p>Temperature of profile during installation</p> | +5 °C | +10 °C | +20 °C | +30 °C |
| | <p>Joint width per linear metre of profile length</p> | 1.4 mm | 1.2 mm | 1.0 mm | 0.8 mm |
| | <p>Recommended minimum joint width at 2.00 m profile length</p> | 2.8 mm | 2.4 mm | 2.0 mm | 1.6 mm |

alwitra stainless steel terrace profile

| | Product specification | Length | Bars/bundle | Price |
|---|---|--------|-------------|-------------------|
|  | <p>Terrace profile 65 (stainless steel V4 A)</p> | 2 m | 5 | on request |
|  | <p>Terrace profile 90 (stainless steel V4 A)</p> | 2 m | 5 | on request |

0.5 joint connections per m are included.

Note: If slabs are laid on alwitra paving slab supports, the alwitra terrace profile made of stainless steel is not suitable as a so-called securing edges.





EVALON® coated metal sheets ¹

| Product specification | Dimensions (per sheet / per coil) | Colour | €/pallet | €/m ² |
|--|-----------------------------------|-------------------------------------|-----------------|------------------|
| Pallet* at 10 sheets (20 m²) | 1 m x 2 m | white/ light grey/ slate grey | 1,040.00 | 52.00 |
| Pallet* at 30 sheets (60 m²) | 1 m x 2 m | | 2,919.00 | 48.65 |
| Pallet* at 100 sheets (200 m²) | 1 m x 2 m | | 9,060.00 | 45.30 |
| Pallet* at 70 sheets (210 m²) | 1 m x 3 m | | 9,513.00 | 45.30 |
| Coils | 1 m x 30 m | | | 48.65 |

¹ EVALON® coated stainless steel metal sheets V4A 1.4404-2B on request.

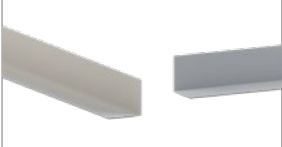
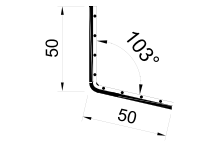
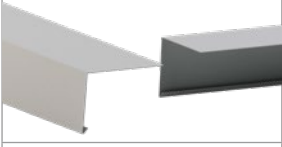
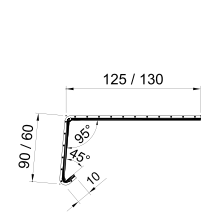
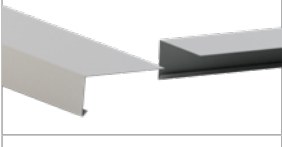
* Only full pallet units per type and colour

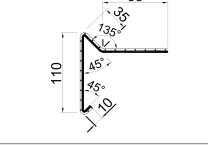
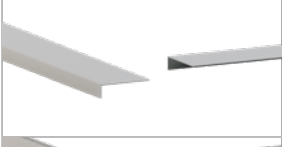
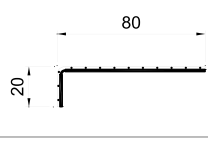
EVALON® coated metal sheet profiles (complete bundles only)

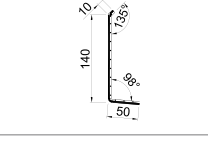
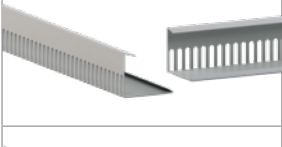
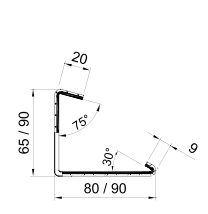
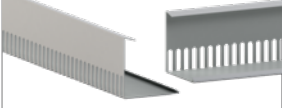
| | Dimensions in mm | Type | Length | Colour | Bars/bundle | €/m |
|---|---|--|--------|-------------------------------------|-------------|--------------|
|  |  | Perimeter fastening | 3 m | white/ light grey/ slate grey | 10 | 6.85 |
|  |  | Eaves flashing 90 | 3 m | white/ light grey/ slate grey | 10 | 14.20 |
|  | | Eaves flashing 60 | | | | 12.80 |
|  |  | Edge trim profile | 3 m | white/ light grey/ slate grey | 8 | 16.70 |
|  |  | Edge trim angle | 3 m | white/ light grey/ slate grey | 10 | 6.85 |
|  |  | Wall flashing | 3 m | white/ light grey/ slate grey | 10 | 12.80 |
|  |  | Gravel stop 65 ² (coated aluminium metal sheet) | 2 m | white/ light grey/ slate grey | 5 | 29.90 |
|  | | Gravel stop 90 ² | | | | 31.60 |

² Gravel stops are not suitable for used roofs (e. g. balconies, terraces)

alwitra installation tool set

Complete set

€/set



186.90

alwitra seam checker

for seam checking

€/piece



11.80

Hot air welding aid

Width: 15 cm; Roll length: 10 m, 25 m

€/m



13.80

EVALASTIC® EPDM waterproofing membranes

| | Product | Product specification | Dimension (m) Length ¹ x Width | Colour | Thick- ness | €/m ² |
|---|------------------------|---|--|------------------------------|----------------|------------------|
|  | EVALASTIC® V | homogeneous sealing layer, with polyester fleece backing | 25 x 1.05 (1.09) ² 25 x 1.55 (1.59) ² | light grey ³ | 1.2 mm | 26.65 |
| | | | | | 1.5 mm | 31.25 |
|  | EVALASTIC® VG | homogeneous sealing layer, with glass fleece / polyester fleece backing | 25 x 1.05 25 x 1.55 | light grey ³ | 1.5 mm | 34.75 |
|  | EVALASTIC® VG | homogeneous sealing layer, with glass fleece / polyester fleece backing | 25 x 1.05 25 x 1.55 | slate grey matt ³ | 1.5 mm | 34.75 |
|  | EVALASTIC® VGSK | homogeneous sealing layer, with glass fleece / polyester fleece backing and self-adhesive coating | 25 x 1.05 | light grey ³ | 1.5 mm | 39.10 |
|  | EVALASTIC® VGSK | homogeneous sealing layer, with glass fleece / polyester fleece backing and self-adhesive coating | 25 x 1.05 | slate grey matt ³ | 1.5 mm | 39.10 |

¹ Surcharge for special lengths (at least 15 m) on request

² with double selvedge (only for 1.5 mm)

³ other colours, for example black on request

EVALASTIC® tapes (standard length 25 m)

| Tape width | EVALASTIC® | | | EVALASTIC® V | | EVALASTIC® VSKA |
|------------|---|---------------------|--------|---|--------|---|
| | homogeneous | | | homogeneous sealing layer with polyester fleece backing | | homogeneous sealing layer with polyester fleece backing and self-adhesive coating |
| | light grey / slate grey matt ¹ | | | light grey ¹ | | light grey / slate grey matt ¹ |
| | €/m | €/m ² | | €/m | | €/m |
| | 1.5 mm | 1.2 mm ² | 1.5 mm | 1.2 mm ² | 1.5 mm | 1.5 mm |
| 16 cm | 5.00 | - | - | - | - | - |
| 20 cm | 6.10 | - | - | - | - | - |
| 25 cm | 7.50 | - | - | - | - | - |
| 33 cm | 9.75 | - | - | - | - | 12.60 ³ |
| 43 cm | - | - | - | - | - | 16.05 ³ |
| 50 cm | 14.60 | - | - | - | - | - |
| 54 cm | - | - | - | 14.90 | 17.75 | - |
| 66 cm | 19.05 | - | - | - | - | 23.55 ⁴ |
| 75 cm | 21.50 | - | - | - | - | - |
| 79 cm | - | - | - | 21.50 | 25.80 | - |
| 86 cm | - | - | - | - | - | 30.75 ⁴ |
| 105 cm | - | 23.45 | 28.05 | - | - | - |
| 155 cm | - | 23.45 | 28.05 | - | - | - |





¹ other colours, for example black on request

² available in light grey, other colours on request



³ with single selvedge (approx. 12.5 cm wide)

⁴ with double selvedge (each approx. 12.5 cm wide)

Adhesives / cleaner

| | Product | Quantity | Packing unit/pallet | €/packing unit | €/tin |
|---|---|-----------------|--|--|--------------------------------|
|  | alwitra adhesive L 40 | 25 kg 9.5 kg | 12 containers 30 containers | 20.25 €/kg 21.80 €/kg | 506.25 207.10 |
|  | alwitra adhesive PUR S750 | 750 ml | 12 tins only full packing units at 12 tins/carton | 51.00 €/l | 38.25 |
|  | alwitra foam gun with 60 cm lance | | | 101.75 €/piece | |
|  | alwitra membrane cleaner not suitable for cleaning of the seam area! | 2 kg | | 23.70 €/kg | 47.40 |
|  | alwitra cleaner L 40 (tool cleaner) | 10 l | | 15.65 €/l | 156.50 |

Primer

| | Product | Quantity | Packing unit/pallet | €/l | €/tin |
|---|---|--------------|--------------------------------------|------------------------------|--------------------------------|
|  | alwitra primer SK-L Solvent-based dispersion for pre-treatment of various substrates for bonding alwitra self-adhesive membranes EVALASTIC® VGSK and EVALASTIC® VSKA. | 25 l 10 l | 12 pieces 42 pieces | 21.15 22.10 | 528.75 221.00 |
|  | alwitra primer SK Solvent-free dispersion for pre-treatment of various substrates for bonding alwitra self-adhesive membranes EVALASTIC® VGSK and EVALASTIC® VSKA. | 25 l 10 l | 12 pieces 44 pieces | 19.40 20.35 | 485.00 203.50 |

EVALASTIC® maintenance walkway tile

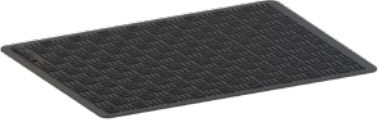
| | Product data | Packing unit | €/tile |
|---|---|--|--------------|
|  | Length x Width: approx. 800 x 600 mm Area: 0.48 m ² Surface: structured, bar height approx. 4 mm Total thickness: approx. 8.5 mm Colour: dark grey | pallet at 200 plates or bundle at 5 tiles (minimum quantity: 1 bundle, complete units only) | 33.60 |

EVALASTIC® standing seam effect profile ¹

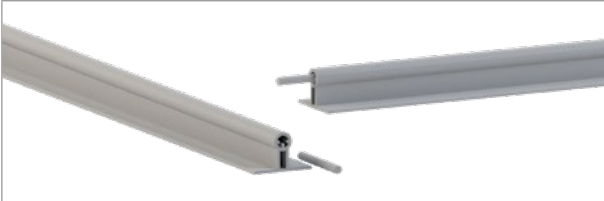
| | Product data | Colour | €/m |
|---|---------------|--|-------------|
|  | Length: 2.0 m | light grey / slate grey matt (other colours on request) | 9.30 |

¹ Joint connections included

EVALASTIC® prefabricated parts

| | Product | Product specification | Colour | Ø internal | €/piece |
|---|------------------------|---|------------------------------|------------|--------------|
|  | Internal corner | for parapets | light grey / slate grey matt | | 8.65 |
|  | External corner | for parapets | light grey / slate grey matt | | 8.65 |
|  | Internal corner | for roof edge trim profiles | light grey / slate grey matt | | 11.70 |
|  | External corner | for roof edge trim profiles | light grey / slate grey matt | | 11.70 |
|  | Sleeve | for penetrations incl. heat shrink tube | light grey / slate grey matt | Ø 50 mm | 73.50 |
| | | | | Ø 80 mm | 82.45 |
| | | | | Ø 110 mm | 90.55 |
|  | Sleeve | for flash protection and cable penetration/fall protection incl. heat shrink tube | light grey / slate grey matt | Ø 18 mm | 32.35 |
| | | | | Ø 26 mm | 36.45 |

Snow guard profile

| Scope of delivery | Price |
|-------------------|--|
| | 1 Stainless steel pillar with retaining clip¹ with fasteners |
| | 2 EVALASTIC® prefabricated part with self-adhesive shrink tube and collar |
| | 3 Stainless steel catching pipes, 26.9 x 2 mm, 6.00 m (5.94 m) with plug-in system |
| | on request |

¹ Pillar distance: calculation according to snow load area and roof geometry

EVALASTIC® coated metal sheets²

| Product specification | Dimensions (per sheet / per coil) | Colour | €/pallet | €/m ² |
|--|-----------------------------------|---------------------------------|-----------------|------------------|
| Pallet* at 10 sheets (20 m²) | 1 m x 2 m | light grey / slate grey matt | 1,027.00 | 51.35 |
| Pallet* at 30 sheets (60 m²) | 1 m x 2 m | | 2,970.00 | 49.50 |
| Coils | 1 m x 30 m | | 47.35 | |

² EVALASTIC® coated stainless steel metal sheets V4A 1.4404-2B on request

* Minimum order quantity: 10 sheets; by not ordering full packing units: packing surcharge of 30.00 €

EVALASTIC® coated metal sheet profiles (complete bundles only)

| | Dimensions in mm | Type | Length | Colour | Bars/bundle | €/m |
|--|------------------|----------------------------|--------|------------------------------------|-------------|--------------|
| | | Perimeter fastening | 2 m | light grey / slate grey matt | 5 | 8.70 |
| | | Eaves flashing 90 | 2 m | light grey / slate grey matt | 5 | 17.70 |
| | | Eaves flashing 60 | | | | 15.80 |



Roof edge trim profiles



T plus, TW 125 plus

Roof edge trim profile T plus

Profile nominal height: 100, 125, 150 or 175 mm

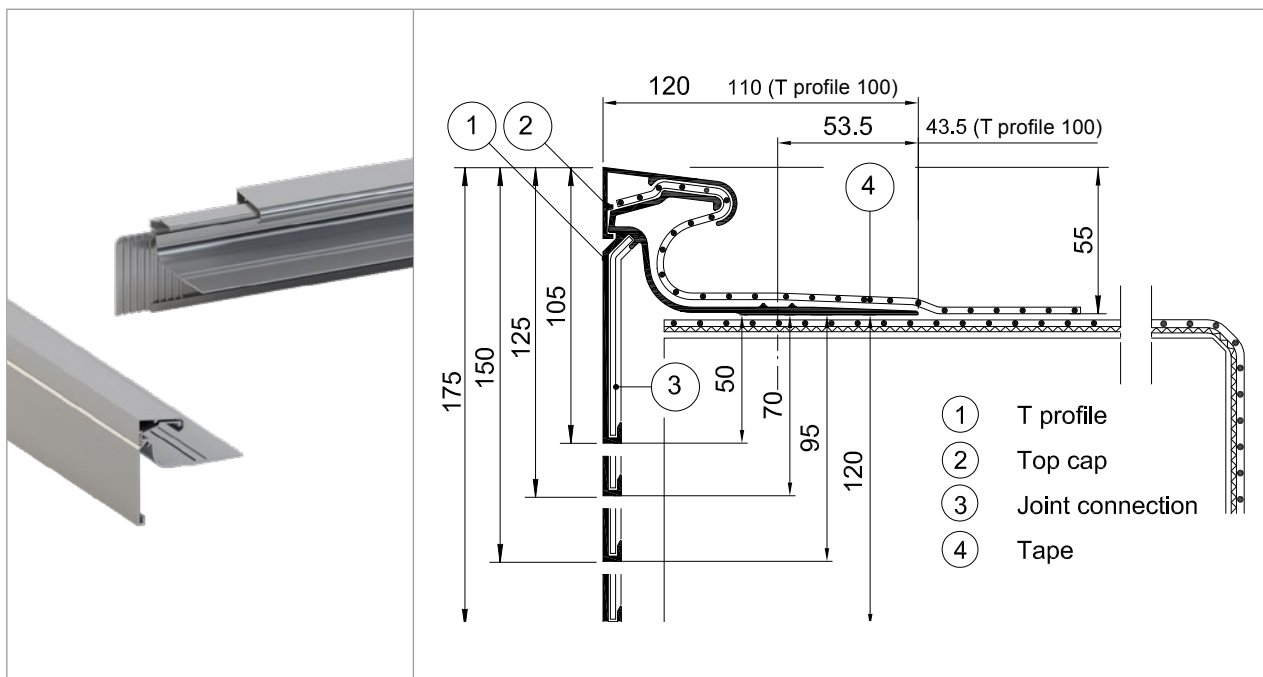

Roof edge trim profile TW 125 plus

Profile nominal height: 125 mm

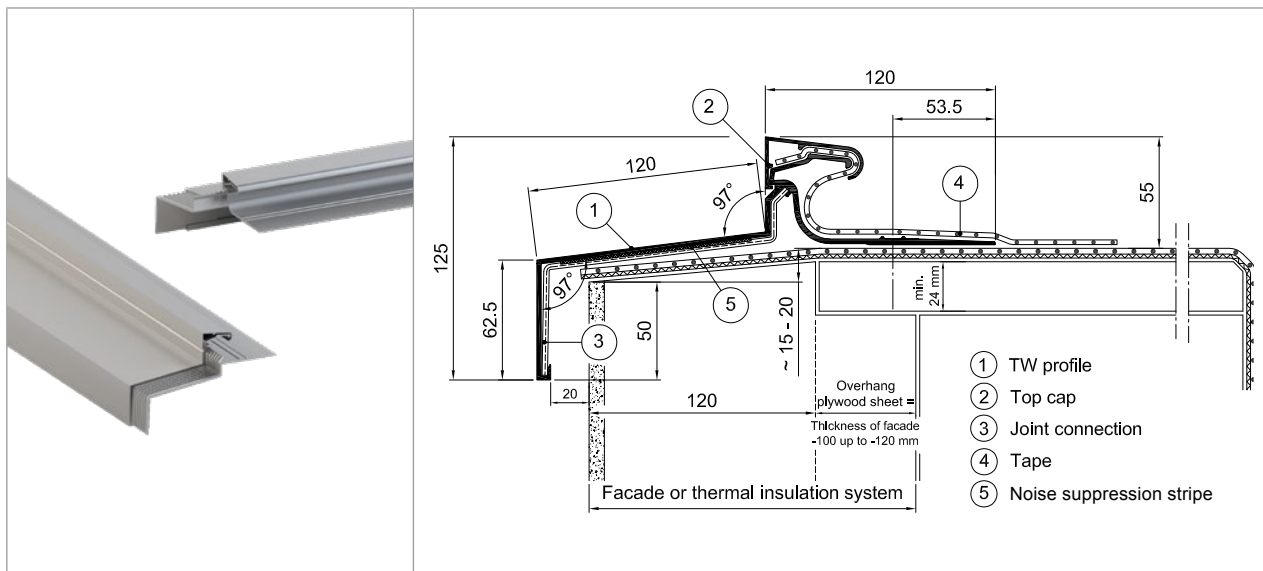

Top cap

| Standard top cap | Large top cap | Top cap for bitumen sheet |
|-------------------------------|-------------------------------------|---------------------------|
| Waterproofing membrane 1.5 mm | Waterproofing membrane up to 2.5 mm | Polymer bitumen sheet |
| | | |

T plus, TW 125 plus

Roof edge trim profile T plus, 2-parts

| Profile nominal height | Packing unit | Mill finish ¹ incl. acc. | Surcharge colour coating ² | 90° corner complete mill finish incl. acc. | Surcharge colour coating corner complete | Closed stop end mill finish | 90° corner surcharge ³ mill finish incl. acc. | Surcharge colour coating stop end / corner surcharge ³ | Additional demand joint connection |
|------------------------|--------------|-------------------------------------|---------------------------------------|--|--|-----------------------------|--|---|------------------------------------|
| mm | bars x m | €/m | €/m | €/piece | €/piece | €/piece | €/piece | €/piece | €/piece |
| 100 | 6 x 5 | 35.75 | 14.25 | 62.40 | 12.60 | 27.15 | 48.10 | 6.90 | 2.55 |
| 125 | 4 x 5 | 40.40 | 14.70 | 68.60 | 12.80 | 27.15 | 52.40 | 6.90 | 2.80 |
| 150 | 4 x 5 | 45.95 | 15.10 | 71.70 | 12.95 | 27.15 | 53.30 | 6.90 | 3.20 |
| 175 | 4 x 5 | 51.50 | 15.55 | 74.45 | 13.15 | 27.15 | 53.85 | 6.90 | 3.75 |

Scope of delivery

| per m profile | per 90° corner |
|---|---|
| 0.2 bars T profile at 5.00 m, 6 x 8 mm slotted holes in e = 250 mm 0.4 bars top cap at 2.50 m 0.2 joint connection | T profile corner, (20/20 cm) Top cap miter for corners at (26.5/26.5 cm), Top cap for bitumen membrane (50/50 cm) 2 joint connection |

Roof edge trim profile TW 125 plus, 2-parts

| Profile nominal height | Packing unit | Mill finish ¹ incl. acc. | Surcharge colour coating ² | 90° corner complete mill finish incl. acc. | Surcharge colour coating corner complete | Closed stop end/wall abutment mill finish ⁴ | 90° corner surcharge ³ mill finish incl. acc. | Surcharge colour coating stop end / wall abutment corner surcharge | Additional demand joint-connection |
|------------------------|--------------|-------------------------------------|---------------------------------------|--|--|--|--|--|------------------------------------|
| mm | bars x m | €/m | €/m | €/piece | €/piece | €/piece | €/piece | €/piece | €/piece |
| 125 | 4 x 2.5 | 65.00 | 19.15 | 106.05 | 26.10 | 71.85 | 64.45 | 13.80 | 8.35 |

Scope of delivery

| per m profile | per 90° corner |
|--|---|
| 0.4 bars TW 125 at 2.50 m, 6 x 8 mm slotted holes in e = 250 mm 0.4 bars top cap at 2.50 m 0.4 joint connection 1.0 noise suppression stripe | Edge trim profile corner TW (external / internal corner, ready for assembly, 32/32 cm; front view of the internal corner 8/8 cm) Top cap miter for corners at (26.5/26.5 cm), Top cap for bitumen membrane (50/50 cm) 2 joint connection |

Tape

| Width | EVALON® 1.5 mm homogeneous | EVALASTIC® 1.5 mm homogeneous |
|-------|----------------------------|-------------------------------|
| cm | €/m | €/m |
| 25 | 7.55 | 7.50 |

Prefabricated pieces

(for connection of 90° standard external / internal corners)

| EVALON® 1.5 mm homogeneous | EVALASTIC® 1.5 mm homogeneous |
|----------------------------|-------------------------------|
| €/piece | €/piece |
| 11.60 | 11.70 |

¹ Surcharge for special lengths: For bars shorter than the standard bar lengths, a surcharge of 20 % of the profile price per meter will be charged

² Prices are only valid for the colour category "alwitra select" (for further information see pages 56-59)

³ "Surcharge for corner" only for offers according to tenders. In case of order the prices for "complete corners incl. accessories" will be invoiced.

⁴ Stop ends / wall abutments welded on profile bar, length 0.32 m;

inclusive 0.385 m top cap, 0.30 m noise suppression stripe and 1 piece joint connection

Roof edge trim profile TA

Profile nominal height: 100, 125, 150, 175 or 200 mm

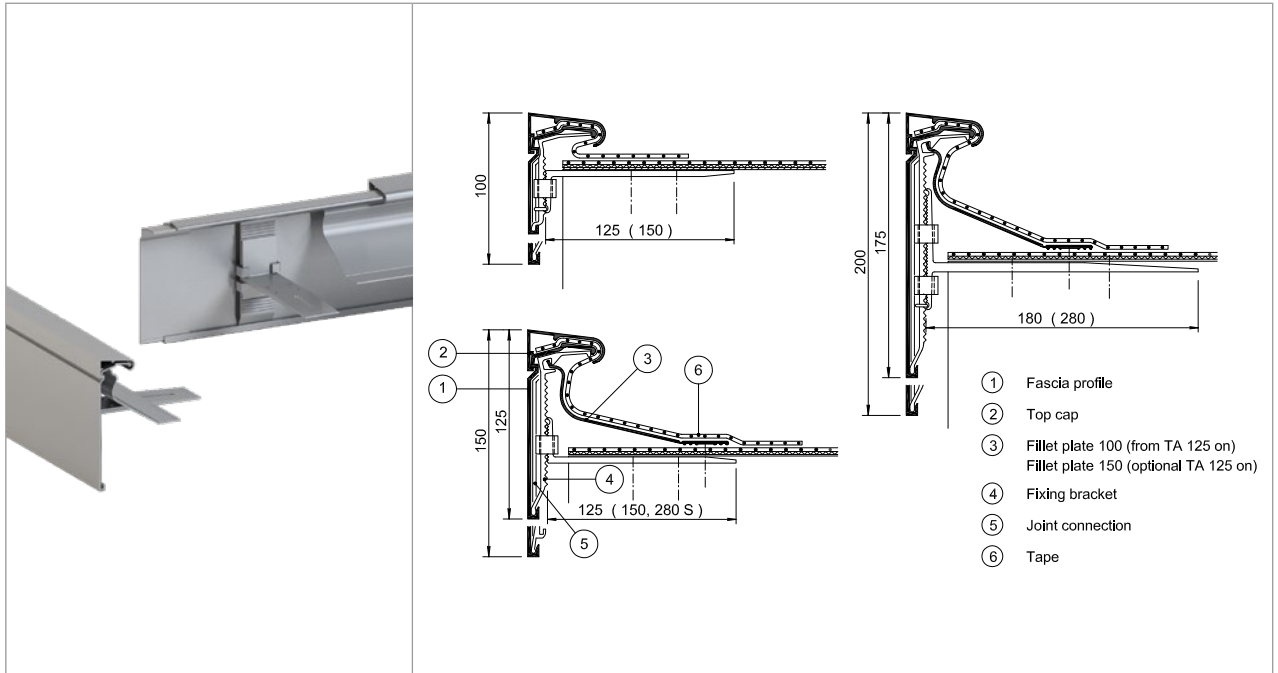

Fixing bracket position for building height up to 20 m

For buildings in wind zone WZ 3 + WZ 4, exposed location, building height over 20 m, additional fixing brackets are required (according to DIN EN 1991-1-4).

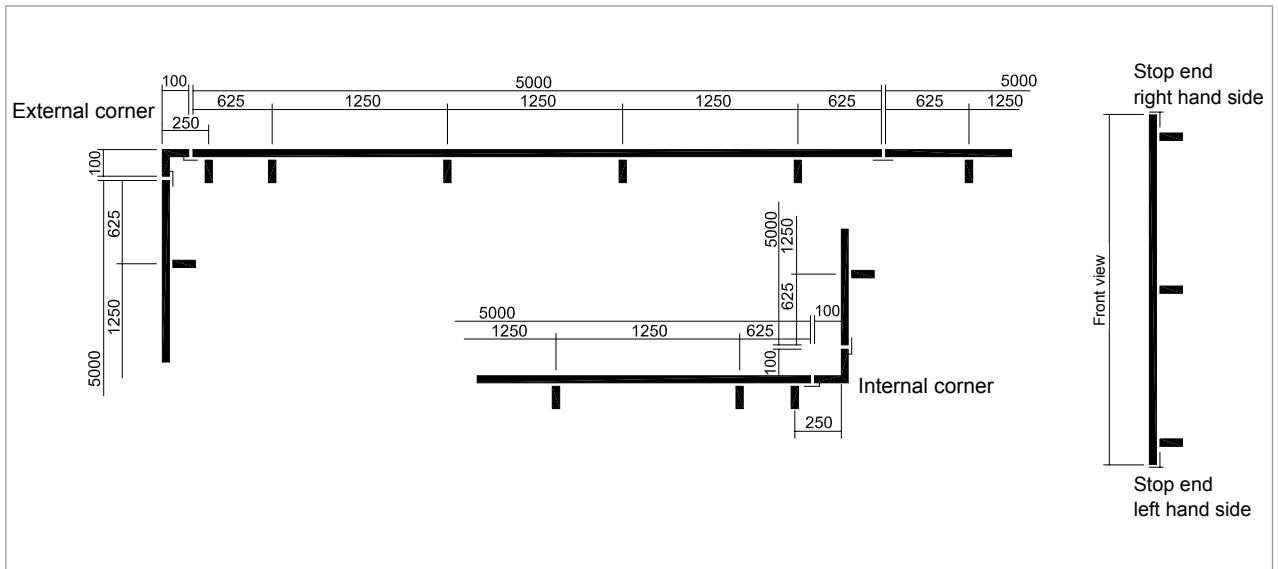

Top cap

| Standard top cap | Large top cap | Top cap for bitumen sheet (starting from TA 125) |
|-------------------------------|-------------------------------------|--|
| Waterproofing membrane 1.5 mm | Waterproofing membrane up to 2.5 mm | Polymer bitumen sheet |
| | | |

Roof edge trim profile TA, multipart

| Profile nominal height | Packing unit | Mill finish ¹ incl. acc. | Surcharge colour coating ² | 90° corner complete mill finish incl. acc. | Surcharge colour coating corner complete | Closed stop end mill finish | 90° corner surcharge ³ mill finish incl. acc. | Surcharge colour coating stop end / corner surcharge ³ | Additional demand fixing bracket | Additional demand joint-connection |
|------------------------|--------------|-------------------------------------|---------------------------------------|--|--|-----------------------------|--|---|----------------------------------|------------------------------------|
| mm | bars x m | €/m | €/m | €/piece | €/piece | €/piece | €/piece | €/piece | €/piece | €/piece |
| 100 | 14 x 5 | 34.15 | 14.25 | 57.50 | 9.75 | 27.15 | 50.65 | 6.90 | 6.80 | 2.35 |
| 125 | 14 x 5 | 41.20 | 14.70 | 61.50 | 9.85 | 27.15 | 53.25 | 6.90 | 7.10 | 2.50 |
| 150 | 7 x 5 | 43.90 | 15.10 | 64.55 | 9.95 | 27.15 | 55.75 | 6.90 | 7.35 | 2.70 |
| 175 | 7 x 5 | 50.10 | 15.55 | 73.05 | 10.05 | 27.15 | 63.00 | 6.90 | 10.35 | 2.80 |
| 200 | 7 x 5 | 56.40 | 16.80 | 81.25 | 10.30 | 27.15 | 69.95 | 6.90 | 12.45 | 3.30 |

| Surcharge | Product specification | €/m | €/corner |
|---|-----------------------------------|------|----------|
| Surcharge for fillet plate | 150 mm | 7.25 | - |
| Surcharge for extended fixing brackets | Fixing bracket 150 (TA 100-150) | 0.25 | 0.25 |
| | Fixing bracket 280 S (TA 125-150) | 3.65 | 4.50 |
| | Fixing bracket 280 (TA 175-200) | 1.90 | 2.40 |

| Scope of delivery (for building height up to 20 m in non-exposed locations, wind zone 1 + 2) | |
|---|--|
| per m profile * | per 90° corner |
| 0.2 bars front profile at 5.00 m 0.4 bars top cap at 2.50 m 0.4 bars fillet plate at 2.50 m (from TA 125 on) 0.2 joint connection 0.8 fixing brackets | Edge trim profile corner (10/10 cm) 2 welded corner joint connections Top cap miter for corners at (26.5/26.5 cm) Top cap for bitumen membrane (50/50 cm) 1 fixing bracket |

* per roof edge 1 additional piece of fixing brackets is required

Tape

| | Width | EVALON® 1.5 mm homogeneous | EVALASTIC® 1.5 mm homogeneous |
|-----------------------------|-------|----------------------------|-------------------------------|
| | cm | €/m | €/m |
| without fillet plate | 16 | 5.05 | 5.00 |
| without fillet plate | 20 | 6.20 | 6.10 |
| Fillet plate 100 | 25 | 7.55 | 7.50 |
| Fillet plate 150 | 33 | 9.80 | 9.75 |

Prefabricated pieces

(for connection of 90° standard external / internal corners)

| EVALON® 1.5 mm homogeneous | EVALASTIC® 1.5 mm homogeneous |
|----------------------------|-------------------------------|
| €/piece | €/piece |
| 11.60 | 11.70 |

¹ Surcharge for special lengths: For bars shorter than the standard bar lengths, a surcharge of 20 % of the profile price per meter will be charged

² Prices are only valid for the colour category "alwitra select" (for further information see pages 56-59)

³ "Surcharge for corner" only for offers according to tenders. In case of order the prices for "complete corners incl. accessories" will be invoiced.

Roof edge trim profile TA-4F

Profile nominal height: 150, 175 or 200 mm

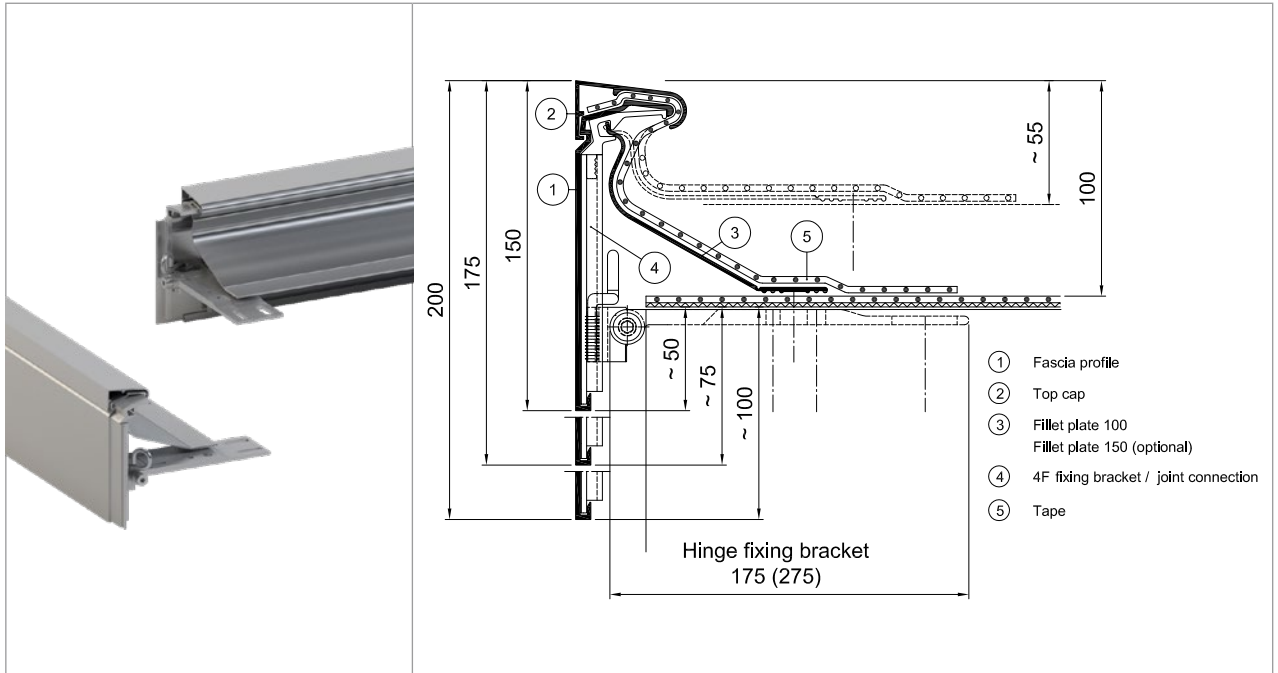

Fixing bracket position for building height up to 20 m

For buildings in wind zone WZ 3 + WZ 4, exposed location, building height over 20 m, additional fixing brackets are required (according to DIN EN 1991-1-4).

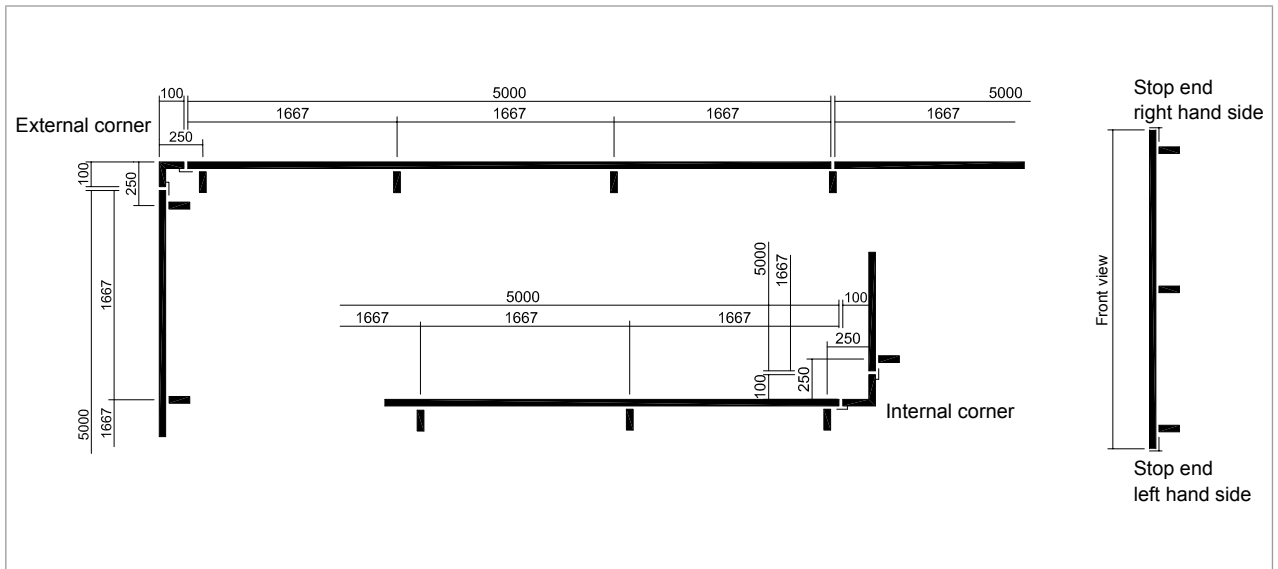

Top cap

| Standard top cap | Large top cap | Top cap for bitumen sheet |
|-------------------------------|-------------------------------------|---------------------------|
| Waterproofing membrane 1.5 mm | Waterproofing membrane up to 2.5 mm | Polymer bitumen sheet |
| | | |

Roof edge trim profile TA-4F, multipart

| Profile nominal height | Packing unit | Mill finish ¹ incl. acc. | Surcharge colour coating ² | 90° corner complete mill finish incl. acc. | Surcharge colour coating corner complete | Closed stop end mill finish | 90° corner surcharge ³ mill finish incl. acc. | Surcharge colour coating stop end/corner surcharge ³ | Additional demand 4F fixing bracket/joint-connection |
|------------------------|--------------|-------------------------------------|---------------------------------------|--|--|-----------------------------|--|---|--|
| mm | bars x m | €/m | €/m | €/piece | €/piece | €/piece | €/piece | €/piece | €/piece |
| 150 | 7 x 5 | 56.05 | 15.10 | 67.00 | 9.95 | 27.15 | 55.75 | 6.90 | 30.80 |
| 175 | 7 x 5 | 60.75 | 15.55 | 75.15 | 10.05 | 27.15 | 63.00 | 6.90 | 32.45 |
| 200 | 7 x 5 | 64.55 | 16.80 | 82.90 | 10.30 | 27.15 | 69.95 | 6.90 | 33.40 |

| Surcharge | €/m | €/piece | €/corner |
|---|------|---------|----------|
| Surcharge for fillet plate 150 mm | 7.25 | - | - |
| Surcharge for extended fixing brackets (275 mm) | 7.00 | - | 11.65 |
| Special inbus key for fixation of 4F fixing bracket | - | 7.45 | - |

Scope of delivery (for building height up to 20 m in non-exposed locations, wind zone 1 + 2)

| per m profile * | per 90° corner |
|---|---|
| 0.2 bars front profile at 5.00 m 0.4 bars top cap at 2.50 m 0.2 bars fillet plate at 5.00 m 0.6 4F fixing brackets/joint connections | Edge trim profile corner (10/10 cm) 2 welded corner joint connections Top cap miter for corners at (26.5/26.5 cm), Top cap for bitumen membrane (50/50 cm) 1 4F fixing bracket/joint connection |

* per roof edge 1 additional piece of fixing brackets is required

Tape

| | Width | EVALON® 1.5 mm homogeneous | EVALASTIC® 1.5 mm homogeneous |
|------------------|-------|----------------------------|-------------------------------|
| | cm | €/m | €/m |
| Fillet plate 100 | 25 | 7.55 | 7.50 |
| Fillet plate 150 | 33 | 9.80 | 9.75 |

Prefabricated pieces

(for connection of 90° standard external / internal corners)

| EVALON® 1.5 mm homogeneous | EVALASTIC® 1.5 mm homogeneous |
|----------------------------|-------------------------------|
| €/piece | €/piece |
| 11.60 | 11.70 |

¹ Surcharge for special lengths: For bars shorter than the standard bar lengths, a surcharge of 20 % of the profile price per meter will be charged

² Prices are only valid for the colour category "alwitra select" (for further information see pages 56-59)

³ "Surcharge for corner" only for offers according to tenders. In case of order the prices for "complete corners incl. accessories" will be invoiced.

TAG 250 – 400

Roof edge trim profile TAG 250 – 400

Profile nominal height: 250, 300, 350, 400 mm

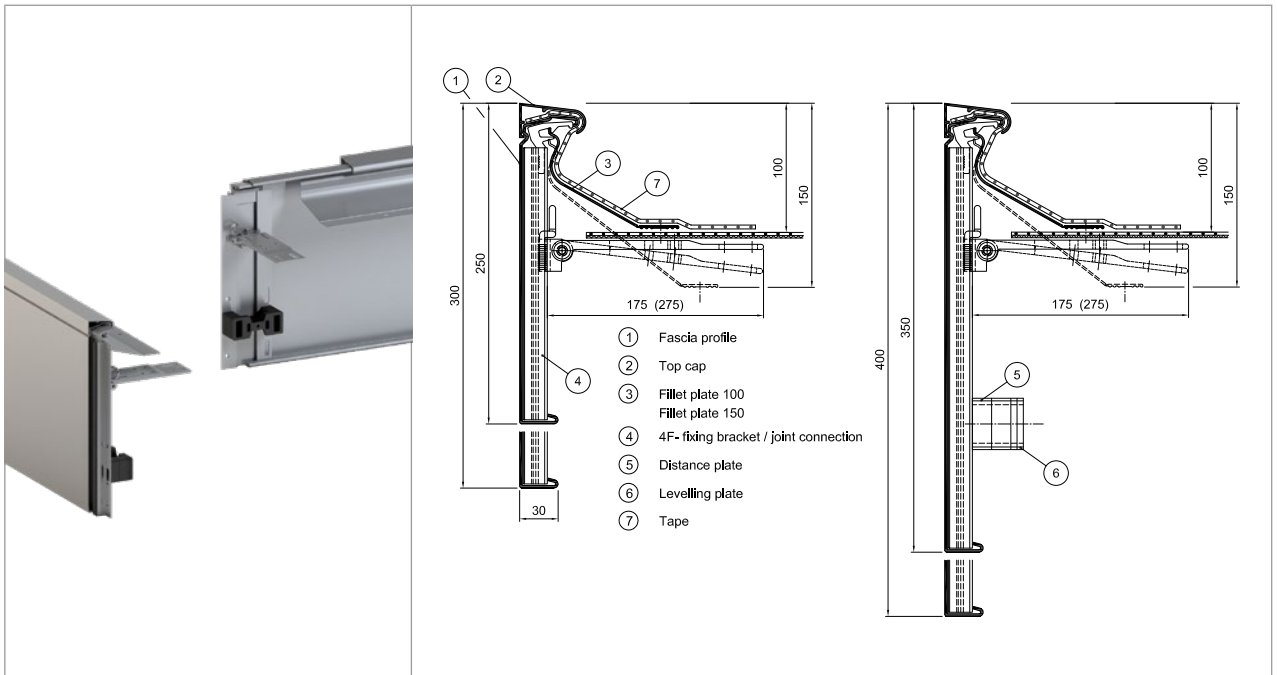

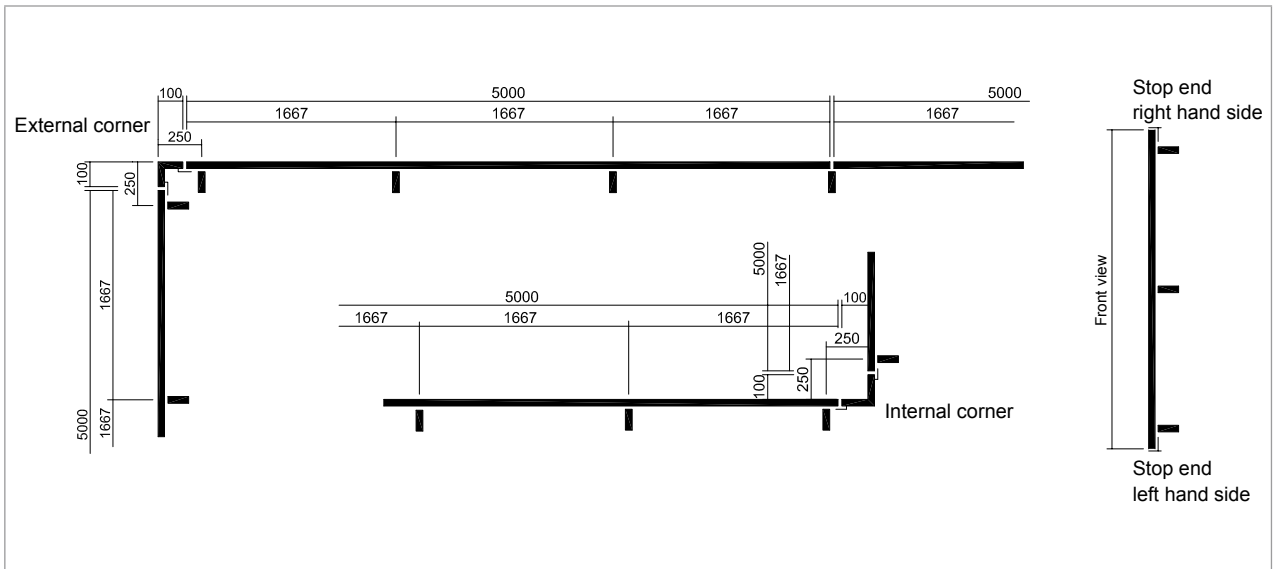

Fixing bracket position for building height up to 20 m

For buildings in wind zone WZ 3 + WZ 4, exposed location, building height over 20 m, additional fixing brackets are required (according to DIN EN 1991-1-4).

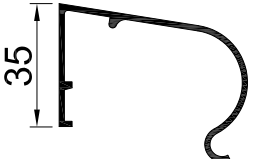

Top cap

| Standard top cap | Large top cap | Top cap for bitumen sheet |
|---|---|---|
| Waterproofing membrane 1.5 mm | Waterproofing membrane up to 2.5 mm | Polymer bitumen sheet |
|  |  |  |

Roof edge trim profile TAG 250 – 400, multipart

| Profile nominal height | Mill finish 2.0 mm protection foiled ¹ incl. acc. | Surcharge colour coating ² | 90° corner complete mill finish incl. acc. | Surcharge colour coating corner complete | Closed stop end mill finish | 90° corner surcharge ³ mill finish incl. acc. | Surcharge colour coating stop end/ corner surcharge ³ | Additional demand 4F fixing bracket/joint-connection |
|------------------------|--|---------------------------------------|--|--|-----------------------------|--|--|--|
| mm | €/m | €/m | €/piece | €/piece | €/piece | €/piece | €/piece | €/piece |
| 250 | 75.15 | 20.85 | 82.00 | 14.05 | 29.45 | 66.95 | 9.85 | 30.05 |
| 300 | 80.50 | 23.15 | 89.20 | 14.50 | 34.05 | 73.10 | 9.85 | 31.00 |
| 350 | 93.20 | 24.40 | 107.20 | 15.85 | 42.90 | 88.55 | 10.95 | 39.00 |
| 400 | 102.15 | 25.00 | 116.60 | 15.95 | 48.05 | 96.15 | 10.95 | 41.40 |

| Surcharge | €/m | €/piece | €/corner |
|---|------|---------|----------|
| Surcharge for fillet plate 150 mm | 7.25 | - | - |
| Surcharge for extended fixing brackets (275 mm) | 7.00 | - | 11.65 |
| Special inbus key for fixation of 4F fixing bracket | - | 7.45 | - |

Scope of delivery TAG 250 – 400 (for building height up to 20 m in non-exposed locations, wind zone 1 + 2)

| per m profile * | per 90° corner |
|--|--|
| 0.2 bars front profile at 5.00 m 0.4 bars top cap at 2.50 m 0.2 bars fillet plate at 5.00 m 0.6 4F fixing brackets / joint connections 1.2 distance plates (for TAG 350 – 400) 1.2 levelling plates (for TAG 350 – 400) | Edge trim profile corner (10/10 cm) 2 welded corner joint connections Top cap miter for corners at (26.5/26.5 cm), Top cap for bitumen membrane (50/50 cm) 1 4F fixing bracket / joint connection 2 distance plates (for TAG 350 – 400) 2 levelling plates (for TAG 350 – 400) |

* per roof edge 1 additional piece of 4F fixing brackets is required

Tape

| | Width | EVALON® 1.5 mm homogeneous | EVALASTIC® 1.5 mm homogeneous |
|------------------|-------|----------------------------|-------------------------------|
| | cm | €/m | €/m |
| Fillet plate 100 | 25 | 7.55 | 7.50 |
| Fillet plate 150 | 33 | 9.80 | 9.75 |

Prefabricated pieces

(for connection of 90° standard external / internal corners)

| EVALON® 1.5 mm homogeneous | EVALASTIC® 1.5 mm homogeneous |
|----------------------------|-------------------------------|
| €/piece | €/piece |
| 11.60 | 11.70 |

¹ Surcharge for special lengths: For bars shorter than the standard bar lengths, a surcharge of 20 % of the profile price per meter will be charged

² Prices are only valid for the colour category "alwitra select" (for further information see pages 56-59)

³ "Surcharge for corner" only for offers according to tenders. In case of order the prices for "complete corners incl. accessories" will be invoiced.

Roof edge trim profile TAG 450 – 1050

Profile nominal height: 450, 475, 500, 1025 or 1050 mm

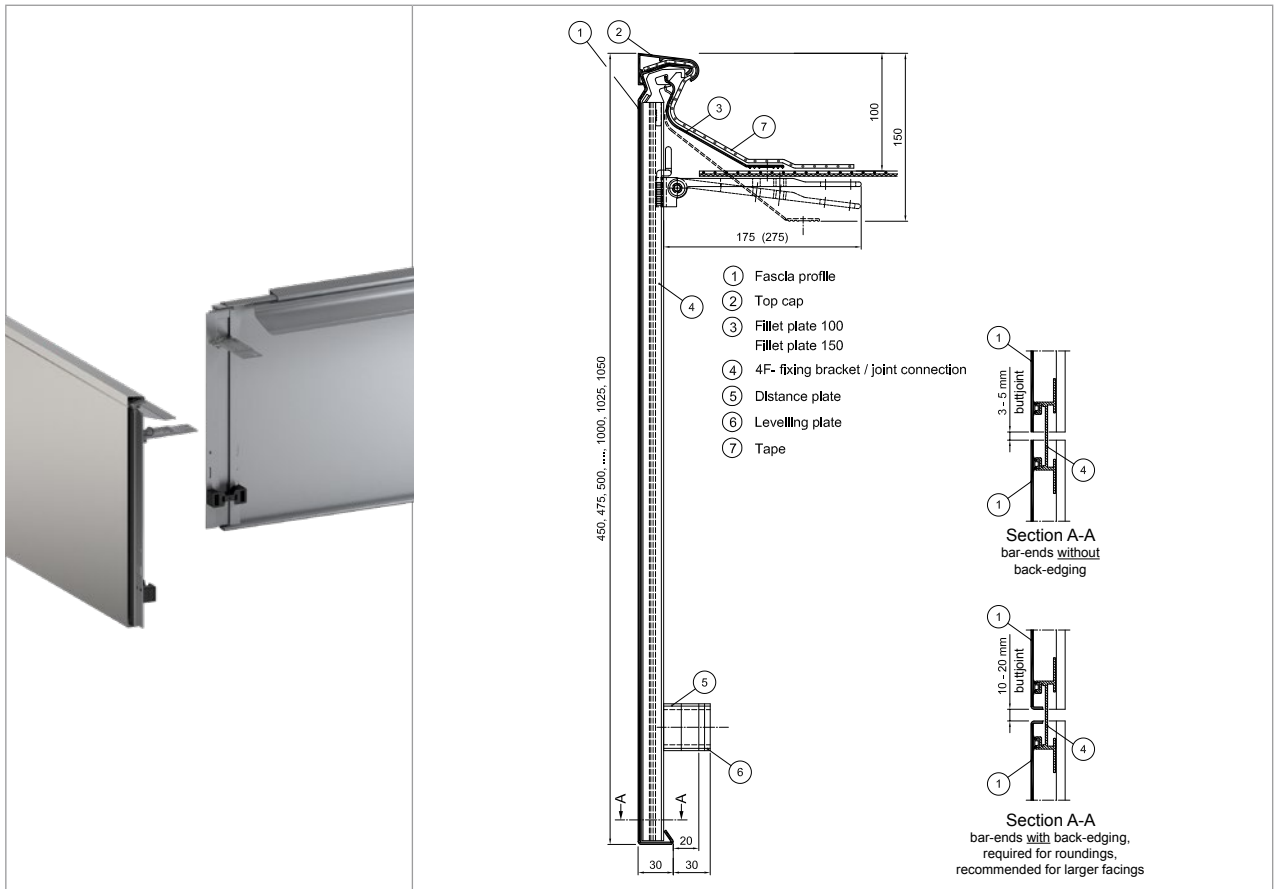

The illustration shows the bracket placement according to the standard scope of delivery.

The required number of brackets depends on the height of the building, the wind load zone and the terrain category and must be specified for each individual project.

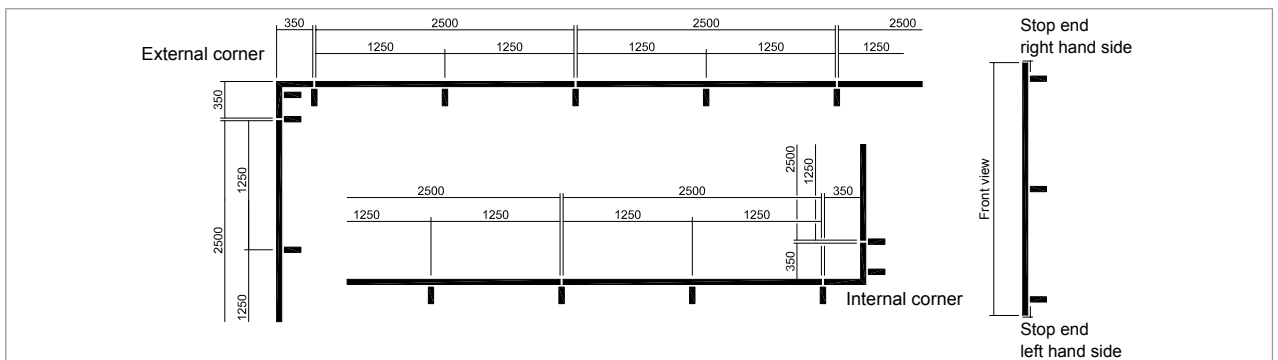

Top cap

| Standard top cap | Large top cap | Top cap for bitumen sheet |
|-------------------------------|-------------------------------------|---------------------------|
| Waterproofing membrane 1.5 mm | Waterproofing membrane up to 2.5 mm | Polymer bitumen sheet |
| | | |

Roof edge trim profile TAG 450 – 1050, multipart

| Profile nominal height | Mill finish 2.0 mm protection foiled ¹ incl. acc. | Surcharge colour coating ² | 90° corner complete mill finish incl. acc. | Surcharge Colour coating corner complete | Closed stop end mill finish | 90° corner surcharge ³ mill finish incl. acc. | Surcharge Colour coating stop end/ corner surcharge ³ | Additional demand 4F fixing bracket/joint-connection |
|------------------------|--|---------------------------------------|--|--|-----------------------------|--|--|--|
| mm | €/m | €/m | €/piece | €/piece | €/piece | €/piece | €/piece | €/piece |
| 450 | 107.10 | 26.80 | 175.30 | 30.90 | 53.30 | 100.30 | 12.10 | 42.80 |
| 475 | 110.65 | 27.60 | 179.70 | 31.45 | 55.60 | 102.20 | 12.10 | 43.75 |
| 500 | 114.20 | 28.35 | 184.00 | 31.95 | 57.90 | 104.05 | 12.10 | 44.65 |
| 525 | 116.90 | 29.35 | 191.55 | 33.25 | 60.90 | 109.70 | 12.70 | 45.55 |
| 550 | 119.55 | 30.30 | 199.05 | 34.55 | 63.85 | 115.35 | 13.30 | 46.45 |
| 575 | 122.35 | 30.95 | 205.80 | 35.00 | 66.65 | 120.15 | 13.30 | 47.40 |
| 600 | 125.15 | 31.60 | 212.60 | 35.45 | 69.40 | 124.95 | 13.30 | 48.30 |
| 625 | 131.60 | 33.05 | 223.80 | 36.45 | 74.65 | 131.65 | 13.30 | 50.15 |
| 650 | 150.10 | 39.00 | 245.65 | 41.85 | 80.70 | 140.55 | 14.55 | 51.90 |
| 675 | 156.60 | 40.05 | 254.25 | 42.60 | 83.60 | 144.60 | 14.55 | 52.85 |
| 700 | 165.25 | 41.10 | 264.15 | 43.35 | 86.40 | 148.45 | 14.55 | 53.85 |
| 725 | 169.65 | 42.10 | 271.35 | 44.05 | 89.25 | 152.55 | 14.55 | 55.10 |
| 750 | 173.85 | 43.25 | 278.25 | 44.85 | 92.05 | 156.55 | 14.55 | 55.60 |
| 775 | 178.25 | 44.10 | 285.75 | 45.45 | 94.95 | 160.95 | 14.55 | 55.95 |
| 800 | 182.50 | 45.20 | 292.45 | 46.20 | 97.75 | 164.70 | 14.55 | 57.45 |
| 825 | 186.85 | 46.20 | 299.85 | 46.90 | 100.65 | 169.05 | 14.55 | 57.65 |
| 850 | 191.30 | 47.35 | 306.70 | 47.70 | 103.30 | 172.75 | 14.55 | 59.30 |
| 875 | 196.95 | 48.30 | 315.00 | 48.40 | 106.20 | 177.10 | 14.55 | 59.45 |
| 900 | 202.70 | 49.65 | 322.60 | 49.35 | 109.00 | 180.70 | 14.55 | 61.15 |
| 925 | 207.75 | 50.70 | 330.45 | 50.05 | 112.15 | 185.00 | 14.55 | 61.35 |
| 950 | 213.00 | 51.65 | 338.00 | 50.75 | 114.60 | 188.90 | 14.55 | 62.95 |
| 975 | 219.15 | 52.85 | 346.50 | 51.55 | 117.65 | 193.05 | 14.55 | 63.15 |
| 1.000 | 225.50 | 53.85 | 355.25 | 52.25 | 120.35 | 197.40 | 14.55 | 63.40 |
| 1.025 | 231.55 | 54.85 | 363.80 | 52.95 | 123.00 | 201.70 | 14.55 | 64.15 |
| 1.050 | 237.80 | 55.90 | 371.50 | 53.70 | 125.80 | 205.00 | 14.55 | 66.60 |

| Surcharge | €/m | €/bar | €/piece | €/corner |
|---|------|-------|---------|----------|
| Surcharge for fillet plate 150 mm | 7.25 | - | - | - |
| Surcharge for extended fixing brackets (275 mm) | 9.30 | - | - | 23.30 |
| Surcharge for back-edging at bar-ends | - | 26.25 | - | 40.35 |
| Special inbus key for fixation of 4F fixing bracket | - | - | 7.45 | - |

| Scope of delivery TAG 450 – 1050 (additional brackets may be required project related) | |
|--|---|
| per m profile * | per 90° corner |
| 0.4 bars front profile at 2.50 m 0.4 bars top cap at 2.50 m 0.4 bars fillet plate at 2.50 m 0.8 4F fixing brackets/joint connections 1.6 distance plates 1.6 levelling plates | Edge trim profile corner (35/35 cm) Top cap miter for corners at (26.5/26.5 cm), Top cap for bitumen membrane (50/50 cm) 2 4F fixing brackets/joint connections 4 distance plates 4 levelling plates |

* per roof edge 1 additional piece of 4F fixing brackets is required

| Tape | | | |
|------------------|-------|----------------------------|-------------------------------|
| | Width | EVALON® 1.5 mm homogeneous | EVALASTIC® 1.5 mm homogeneous |
| | cm | €/m | €/m |
| Fillet plate 100 | 25 | 7.55 | 7.50 |
| Fillet plate 150 | 33 | 9.80 | 9.75 |

| Prefabricated pieces (for connection of 90° standard external / internal corners) | |
|--|-------------------------------|
| EVALON® 1.5 mm homogeneous | EVALASTIC® 1.5 mm homogeneous |
| €/piece | €/piece |
| 11.60 | 11.70 |

¹ Surcharge for special lengths: For bars shorter than the standard bar lengths, a surcharge of 20 % of the profile price per meter will be charged

² Prices are only valid for the colour category "alwitra select" (for further information see pages 56-59)

³ "Surcharge for corner" only for offers according to tenders. In case of order the prices for "complete corners incl. accessories" will be invoiced.

Roof edge trim profiles

art-line 1



alwitra

Roof edge trim profile art-line 1

| | | Profile options art-line 1 | | |
|--|--|----------------------------|--|--|
| | <p>1 Fascia profile 2 Top cap 3 Fillet plate 100 Fillet plate 150 4 4F-fixing bracket / joint connection 5 Distance plate 6 Levelling plate 7 Tape</p> | | | |
| | | | | |
| | | | | |
| | | | | |
| | | | | |

The illustration shows the bracket placement according to the standard scope of delivery.
The required number of brackets depends on the height of the building, the wind load zone and the terrain category and must be specified for each individual project.

| | | Front face (external corner) |
|---|---|------------------------------|
| <p>Long corner leg 750 - 1250 Additional fixing bracket (nominal width > 200) External corner Internal corner Long corner leg 750 - 1250</p> | <p>Stop end / wall abutment right hand side Stop end / wall abutment left hand side</p> | |

Top cap

| Standard top cap | Large top cap | Top cap for bitumen sheet |
|-------------------------------|-------------------------------------|---------------------------|
| Waterproofing membrane 1.5 mm | Waterproofing membrane up to 2.5 mm | Polymer bitumen sheet |
| | | |

Roof edge trim profiles

art-line 1



alwitra

Roof edge trim profile art-line 1, multipart

| Profile nominal height | Mill finish 2.0 mm protection foiled ¹ incl. acc. | Surcharge colour coating ² | Closed stop end wall abutment mill finish | 90° corner surcharge ³ mill finish incl. acc. | Surcharge colour coating corner/stop end/wall abutment | Additional demand 4F fixing bracket/joint connection |
|------------------------|--|---------------------------------------|---|--|--|--|
| mm | €/m | €/m | €/Stück | €/Stück | €/Stück | €/Stück |
| 240 263 309 | 179.15 | 28.95 | 52.85 | 148.50 | 17.80 | 69.95 |
| 245 267 313 | 183.70 | 31.50 | 58.50 | 164.95 | 17.80 | 81.45 |
| 249 272 317 | 187.15 | 33.30 | 63.65 | 184.35 | 17.80 | 83.35 |
| 253 276 322 | 194.90 | 35.40 | 70.35 | 204.45 | 20.75 | 85.05 |
| 258 281 326 | 204.00 | 36.80 | 76.30 | 224.00 | 20.75 | 89.25 |

Order information: art-line 1 nominal width / front face height / abument height

Other dimensions and shapes on request

| Surcharge | €/m | €/piece | €/corner |
|--|--------------|-------------|--------------|
| Surcharge for fillet plate 150 mm | 7.25 | - | - |
| Surcharge for extended fixing brackets (275 mm) | 13.95 | - | 23.30 |
| Special inbus key for fixation of 4F fixing bracket | - | 7.45 | - |

Scope of delivery art-line 1 (for building height up to 20 m in non-exposed locations, wind zone 1 + 2)

| per m profile | per 90° external corner | per 90° internal corner |
|---|--|---|
| 0.4 bars front profile at 2.50 m 0.4 bars top cap at 2.50 m 0.4 bars fillet plate at 2.50 m 1.2 4F fixing brackets / joint connections with security springs 2.4 distance plates / levelling plates | Front profile external corners Top cap miter for corners at (26.5/26.5 cm), Top cap for bitumen membrane (50/50 cm) 2 4F fixing brackets / joint connections with security springs 1 corner fixing bracket (nominal width > 200) 4 distance plates / levelling plates | Front profile internal corners Top cap miter for corners at (26.5/26.5 cm), Top cap for bitumen membrane (50/50 cm) 2 4F fixing brackets / joint connections with security springs 4 distance plates / levelling plates |

* per roof edge 1 additional piece of 4F fixing brackets is required

Tape

| | Width | EVALON® nominal thickness 1.5 mm | EVALASTIC® nominal thickness 1.5 mm |
|-------------------------|-------|----------------------------------|-------------------------------------|
| | cm | €/m | €/m |
| Fillet plate 100 | 25 | 7.55 | 7.50 |
| Fillet plate 150 | 33 | 9.80 | 9.75 |

Prefabricated pieces

(for connection of 90° standard external / internal corners)

| EVALON® nominal thickness 1.5 mm | EVALASTIC® nominal thickness 1.5 mm |
|----------------------------------|-------------------------------------|
| €/piece | €/piece |
| 11.60 | 11.70 |

¹ Surcharge for special lengths: For bars shorter than the standard bar lengths, a surcharge of 20 % of the profile price per meter will be charged

² Prices are only valid for the colour category "alwitra select" (for further information see pages 56-59)

³ "Surcharge for corner" only for offers according to tenders. In case of order the prices for "complete corners incl. accessories" will be invoiced.

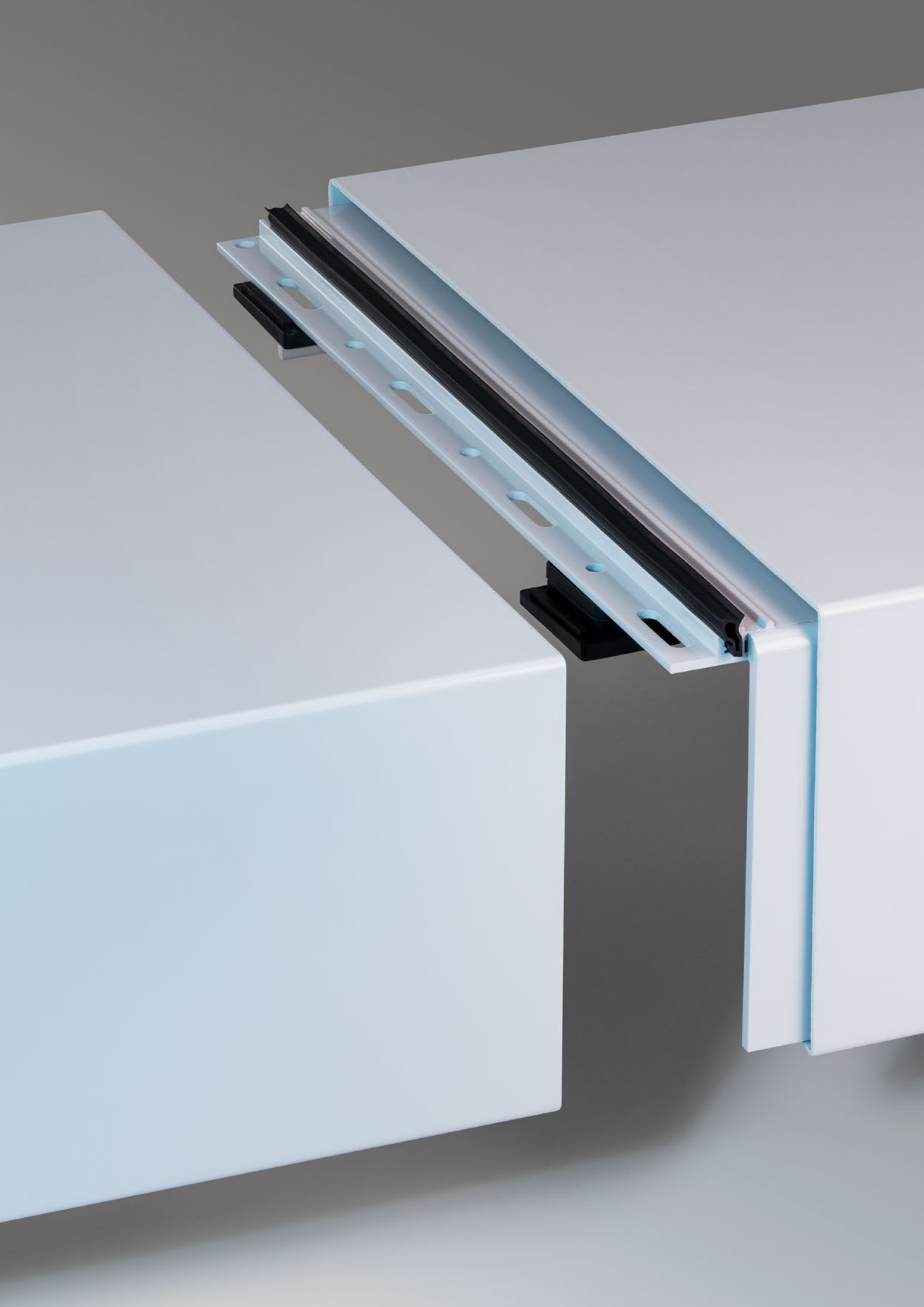

Wall capping profiles

MAG-4 (available ex stock)

Wall capping profile MAG-4 (available ex stock)

Front face height: 100, 125 or 150 mm - Back face height: 65 mm

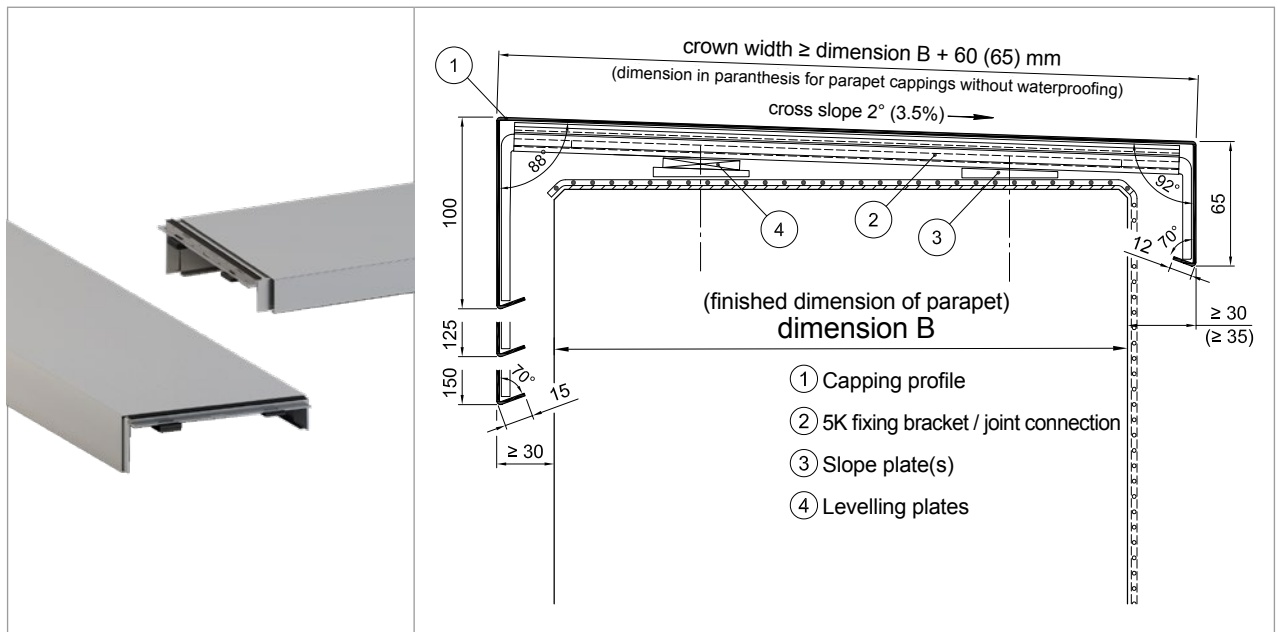

Standard fixing bracket distance (up to crown width 400 mm: 1.25 m, crown width 405 – 550 mm: 1.00 m)

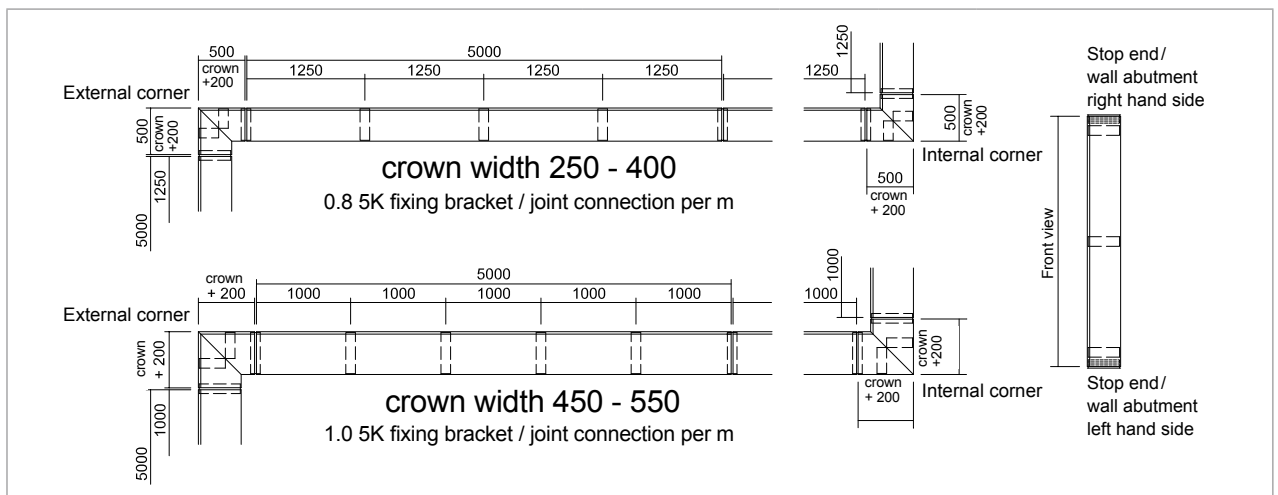

Maximum building heights for standard fixing bracket distance depending on wind load zone and terrain category according to DIN EN 1991-1-4 (Eurocode), material thickness and crown width

| Material thickness in mm | 1.5 | | | | | | 2.0 | | | | | |
|--|----------------------|------|------|------|------|-------|-------|------|------|-------|--------|--------|
| | 250 | 300 | 350 | 400 | 450 | 500 | 550 | 600 | 650 | 700 | 750 | |
| max. building height in wind load zone 1 | Terrain category II | 25 m | 25 m | 25 m | 25 m | 18 m | 7 m | 25 m | 24 m | 18 m | 13 m | 7.5 m |
| | Mixed profile inland | 25 m | 25 m | 25 m | 25 m | 25 m | 14 m | 25 m | 25 m | 25 m | 20 m | 15 m |
| | Terrain category III | 25 m | 25 m | 25 m | 25 m | 25 m | 19 m | 25 m | 25 m | 25 m | 25 m | 20 m |
| max. building height in wind load zone 2 | Terrain category II | 25 m | 25 m | 25 m | 21 m | 7.5 m | - | 15 m | 10 m | 7.5 m | 6 m | - |
| | Mixed profile inland | 25 m | 25 m | 25 m | 25 m | 15 m | 8.5 m | 23 m | 18 m | 15 m | 12 m | 9 m |
| | Terrain category III | 25 m | 25 m | 25 m | 25 m | 20 m | 10 m | 25 m | 25 m | 19 m | 15.5 m | 10.5 m |
| max. building height in wind load zone 3 | Mixed profile inland | 25 m | 25 m | 25 m | 18 m | 9 m | - | 14 m | 11 m | 9 m | 7 m | - |
| | Terrain category III | 25 m | 25 m | 25 m | 23 m | 11 m | - | 18 m | 14 m | 11 m | 8 m | - |

In case of different building heights and wind-exposed areas (e.g. wind load zone 4, coastal proximity, building locations > 800 m above sea level, exposed position) additional fixing brackets are required.

MAG-4 (available ex stock)

Wall capping profile MAG-4 (available ex stock)

Front face height: 100, 125 or 150 mm - Back face height: 65 mm

| stock piled shapes of cross-sections with shorter delivery time and price advantage Mill finish protection foiled ¹ incl. 5K fixing bracket / joint connection for standard fixing bracket distance | | Surcharge colour coating ² | 90° corner complete mill finish incl. acc. | Surcharge colour coating corner complete | Stop end/wall abutment mill finish | 90° corner surcharge ³ mill finish incl. acc. | Surcharge colour coating stop end / wall abutment corner surcharge ³ | Additional demand 5K fixing bracket / joint-connection |
|--|-------|---------------------------------------|--|--|------------------------------------|--|---|--|
| 1.5 mm | €/m | €/m | €/piece | €/piece | €/piece | €/piece | €/piece | €/piece |
| 250/100/65 | 46.50 | 26.15 | 149.30 | 37.75 | 49.35 | 102.80 | 11.60 | 18.25 |
| 300/100/65 | 50.40 | 29.05 | 158.10 | 41.45 | 54.05 | 107.70 | 12.40 | 19.05 |
| 350/100/65 | 54.30 | 31.95 | 172.35 | 48.35 | 58.75 | 112.60 | 13.20 | 19.85 |
| 400/100/65 | 62.00 | 34.85 | 191.90 | 55.85 | 63.45 | 117.50 | 14.00 | 20.65 |
| 450/100/65 | 65.90 | 37.75 | 208.10 | 63.90 | 68.15 | 122.40 | 14.80 | 21.45 |
| 400/125/65 | 64.00 | 36.30 | 196.75 | 58.00 | 65.80 | 119.95 | 14.40 | 21.05 |
| 450/125/65 | 67.85 | 39.20 | 213.10 | 66.20 | 70.50 | 124.85 | 15.20 | 21.85 |
| 2.0 mm | €/m | €/m | €/piece | €/piece | €/piece | €/piece | €/piece | €/piece |
| 500/125/65 | 87.60 | 42.10 | 252.40 | 74.95 | 75.20 | 129.75 | 16.00 | 22.65 |
| 500/150/65 | 90.10 | 43.55 | 258.35 | 77.40 | 77.55 | 132.20 | 16.40 | 23.05 |
| 550/150/65 | 95.10 | 46.45 | 279.75 | 86.90 | 82.25 | 137.10 | 17.20 | 23.85 |

Crown widths 250 up to 450 mm in 1.5 mm thick aluminium sheet
Crown widths 500 and 550 mm in 2.0 mm thick aluminium sheet

Order information: MAG-4 crown width / front face height / back face height / sheet thickness

Scope of delivery MAG-4

| per m profile | per 90° external corner resp. per 90° internal corner |
|--|---|
| 0.2 bars wall capping profile at 5.00 m 0.8 5K fixing brackets / joint connection (crown width up to 400 mm) 1.0 5K fixing bracket / joint connection (crown width 405 up to 650 mm) Slope plates, levelling plates | Capping external corner resp. capping internal corner - for crown width up to 300 mm: corner leg length = 500 mm - for crown width > 300 mm: corner leg length = crown width + 200 mm 1 5K fixing bracket / joint connection 2 5K corner fixing brackets (front face resp. back face) Slope plates, levelling plates |

In case of different building heights and wind-exposed areas (e.g. wind load zone 4, coastal proximity, building locations > 800 m above sea level, exposed position) additional fixing brackets are required.

| Surcharge | €/bag |
|-------------------------------------|-------|
| Levelling plates (bag at 50 pieces) | 25.00 |

¹ Surcharge for special lengths: For bars shorter than the standard bar lengths, a surcharge of 20 % of the profile price per meter will be charged

² Prices are only valid for the colour category "alwitra select" (for further information see pages 56-59)

³ "Surcharge for corner" only for offers according to tenders. In case of order the prices for "complete corners incl. accessories" will be invoiced.

MAG-4

Wall capping profile MAG-4

Front face height: 75, 100, 125, 150, 175, 200 mm - Back face height: 67, 65, 100, 125, 150, 175, 200 mm

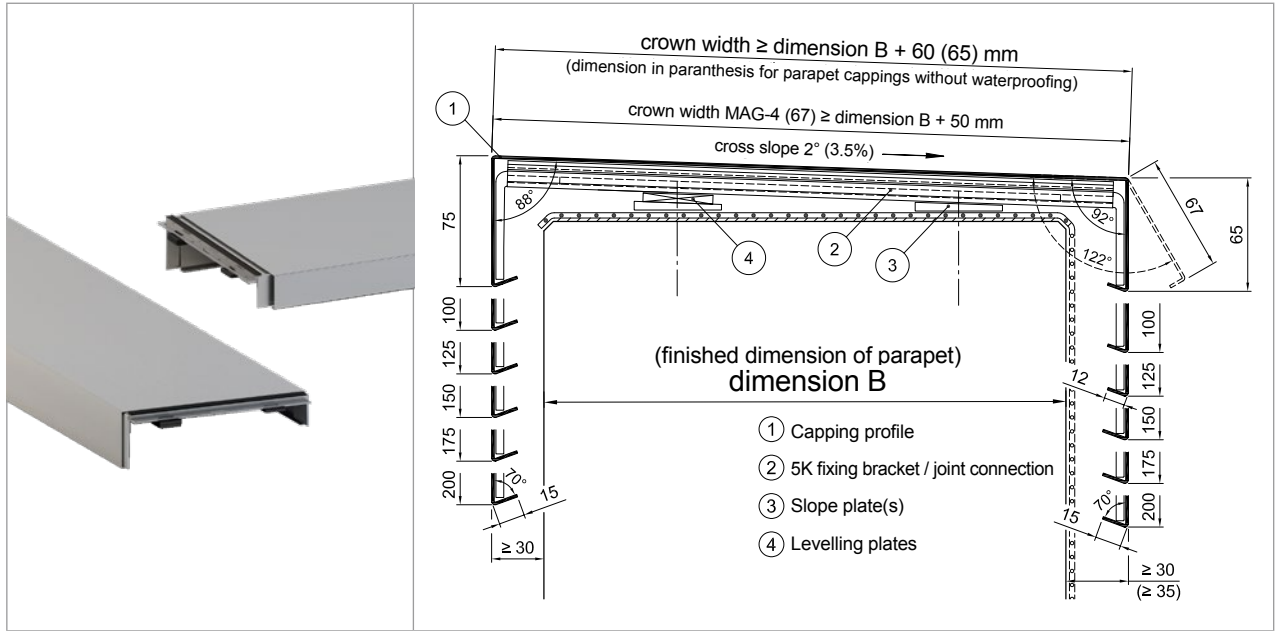

Standard fixing bracket distance (up to crown width 400 mm: 1.25 m, crown width 405 – 750 mm: 1.00 m)

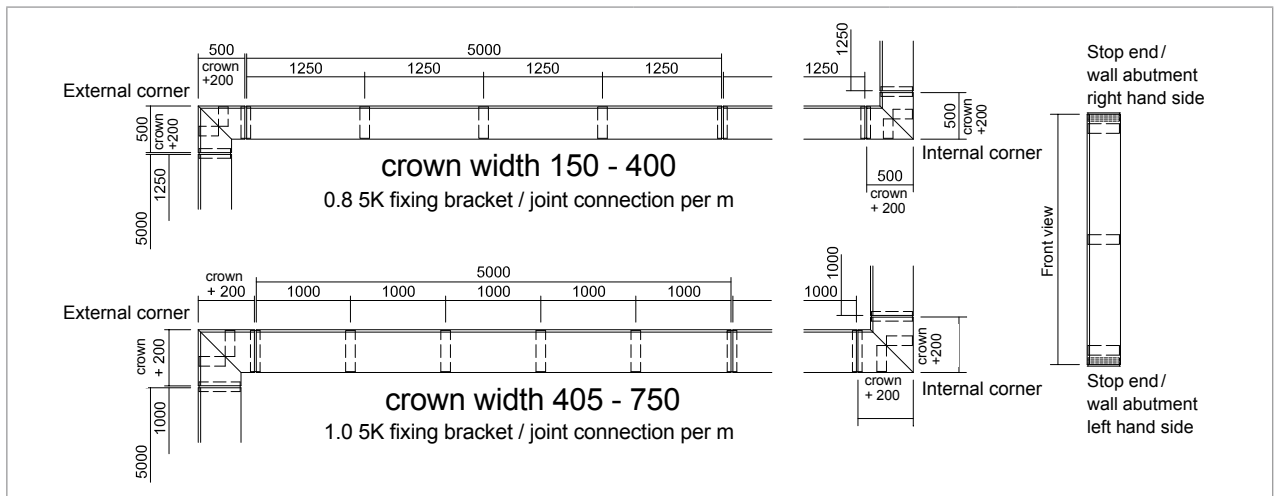

Maximum building heights for standard fixing bracket distance depending on wind load zone and terrain category according to DIN EN 1991-1-4 (Eurocode), material thickness and crown width

| Material thickness in mm | 1.5 | | | | | | 2.0 | | | | | |
|--|----------------------|------|------|------|------|-------|-------|------|------|-------|--------|--------|
| | 250 | 300 | 350 | 400 | 450 | 500 | 550 | 600 | 650 | 700 | 750 | |
| max. building height in wind load zone 1 | Terrain category II | 25 m | 25 m | 25 m | 25 m | 18 m | 7 m | 25 m | 24 m | 18 m | 13 m | 7.5 m |
| | Mixed profile inland | 25 m | 25 m | 25 m | 25 m | 25 m | 14 m | 25 m | 25 m | 25 m | 20 m | 15 m |
| | Terrain category III | 25 m | 25 m | 25 m | 25 m | 25 m | 19 m | 25 m | 25 m | 25 m | 25 m | 20 m |
| max. building height in wind load zone 2 | Terrain category II | 25 m | 25 m | 25 m | 21 m | 7.5 m | - | 15 m | 10 m | 7.5 m | 6 m | - |
| | Mixed profile inland | 25 m | 25 m | 25 m | 25 m | 15 m | 8.5 m | 23 m | 18 m | 15 m | 12 m | 9 m |
| | Terrain category III | 25 m | 25 m | 25 m | 25 m | 20 m | 10 m | 25 m | 25 m | 19 m | 15.5 m | 10.5 m |
| max. building height in wind load zone 3 | Mixed profile inland | 25 m | 25 m | 25 m | 18 m | 9 m | - | 14 m | 11 m | 9 m | 7 m | - |
| | Terrain category III | 25 m | 25 m | 25 m | 23 m | 11 m | - | 18 m | 14 m | 11 m | 8 m | - |

In case of different building heights and wind-exposed areas (e.g. wind load zone 4, coastal proximity, building locations > 800 m above sea level, exposed position) additional fixing brackets are required.

MAG-4

Wall capping profile MAG-4

Front face height: 75, 100, 125, 150, 175, 200 mm - Back face height: 67, 65, 100, 125, 150, 175, 200 mm

| Girth up to (crown width 150 mm – max. 750 mm) mm | Mill finish protection foiled ¹ incl. 5K fixing bracket/joint connection for standard fixing bracket distance | | Surcharge colour coating ² €/m | Stop end/ wall abutment mill finish €/piece | 90° corner surcharge ³ mill finish €/piece | Surcharge colour coating corner/stop end/ wall abutment €/piece | Additional demand 5K fixing bracket/ joint connection €/piece |
|---|---|--------|--|--|--|---|---|
| | 1.5 mm | 2.0 mm | | | | | |
| 300 | 39.30 | 45.80 | 17.45 | 35.25 | 88.10 | 9.20 | 15.85 |
| 325 | 41.25 | 48.30 | 18.90 | 37.60 | 90.55 | 9.60 | 16.25 |
| 350 | 43.20 | 50.80 | 20.35 | 39.95 | 93.00 | 10.00 | 16.65 |
| 375 | 45.15 | 53.30 | 21.80 | 42.30 | 95.45 | 10.40 | 17.05 |
| 400 | 47.10 | 55.80 | 23.25 | 44.65 | 97.90 | 10.80 | 17.45 |
| 425 | 49.05 | 58.30 | 24.70 | 47.00 | 100.35 | 11.20 | 17.85 |
| 450 | 51.00 | 60.80 | 26.15 | 49.35 | 102.80 | 11.60 | 18.25 |
| 475 | 52.95 | 63.30 | 27.60 | 51.70 | 105.25 | 12.00 | 18.65 |
| 500 | 54.90 | 65.80 | 29.05 | 54.05 | 107.70 | 12.40 | 19.05 |
| 525 | 56.85 | 68.30 | 30.50 | 56.40 | 110.15 | 12.80 | 19.45 |
| 550 | 58.80 | 70.80 | 31.95 | 58.75 | 112.60 | 13.20 | 19.85 |
| 575 | 64.55 | 77.10 | 33.40 | 61.10 | 115.05 | 13.60 | 20.25 |
| 600 | 66.50 | 79.60 | 34.85 | 63.45 | 117.50 | 14.00 | 20.65 |
| 625 | 68.45 | 82.10 | 36.30 | 65.80 | 119.95 | 14.40 | 21.05 |
| 650 | 70.40 | 84.60 | 37.75 | 68.15 | 122.40 | 14.80 | 21.45 |
| 675 | 72.35 | 87.10 | 39.20 | 70.50 | 124.85 | 15.20 | 21.85 |
| 700 | 74.30 | 89.60 | 40.65 | 72.85 | 127.30 | 15.60 | 22.25 |
| 725 | 76.25 | 92.10 | 42.10 | 75.20 | 129.75 | 16.00 | 22.65 |
| 750 | 78.20 | 94.60 | 43.55 | 77.55 | 132.20 | 16.40 | 23.05 |
| 775 | - | 97.10 | 45.00 | 79.90 | 134.65 | 16.80 | 23.45 |
| 800 | - | 99.60 | 46.45 | 82.25 | 137.10 | 17.20 | 23.85 |
| 825 | - | 102.10 | 47.90 | 84.60 | 139.55 | 17.60 | 24.25 |
| 850 | - | 104.60 | 49.35 | 86.95 | 142.00 | 18.00 | 24.65 |
| 875 | - | 107.10 | 50.80 | 89.30 | 144.45 | 18.40 | 25.05 |
| 900 | - | 109.60 | 52.25 | 91.65 | 146.90 | 18.80 | 25.45 |
| 925 | - | 112.10 | 53.70 | 94.00 | 149.35 | 19.20 | 25.85 |
| 950 | - | 114.60 | 55.15 | 96.35 | 151.80 | 19.60 | 26.25 |
| 975 | - | 117.10 | 56.60 | 98.70 | 154.25 | 20.00 | 26.65 |
| 1,000 | - | 119.60 | 58.05 | 101.05 | 156.70 | 20.40 | 27.05 |

Crown widths selectable in intervals of 5 mm

Crown widths 150 up to 500 mm in 1.5 and 2.0 mm thick aluminium sheet

Crown widths > 500 up to 750 mm in 2.0 mm thick aluminium sheet

Deviant front face heights / back face heights / crown widths / sheet thicknesses on request

Order information: MAG-4 crown width / front face height / back face height / sheet thickness

Scope of delivery MAG-4

per m profile

per 90° external corner resp. per 90° internal corner

0.2 bars wall capping profile at 5.00 m

0.8 5K fixing brackets / joint connection (crown width up to 400 mm)

1.0 5K fixing bracket / joint connection (crown width 405 up to 750 mm)

Slope plates, levelling plates

Capping external corner resp. capping internal corner

- for crown width up to 300 mm: corner leg length = 500 mm

- for crown width > 300 mm: corner leg length = crown width + 200 mm

1 5K fixing bracket / joint connection

2 5K corner fixing brackets (front face resp. back face)

Slope plates, levelling plates

In case of different building heights and wind-exposed areas (e.g. wind load zone 4, coastal proximity, building locations > 800 m above sea level, exposed position) additional fixing brackets are required.

Surcharge

€/bag

Levelling plates (bag at 50 pieces)

25.00

¹ Surcharge for special lengths: For bars shorter than the standard bar lengths, a surcharge of 20 % of the profile price per meter will be charged

² Prices are only valid for the colour category "alwitra select" (for further information see pages 56-59)

³ "Surcharge for corner" only for offers according to tenders. In case of order the prices for "complete corners incl. accessories" will be invoiced.

Wall capping profile MAG-6

Front face height: 85, 110, 135, 160, 185, 210 mm - Back face height: 67, 65, 100, 125, 150, 175, 200 mm

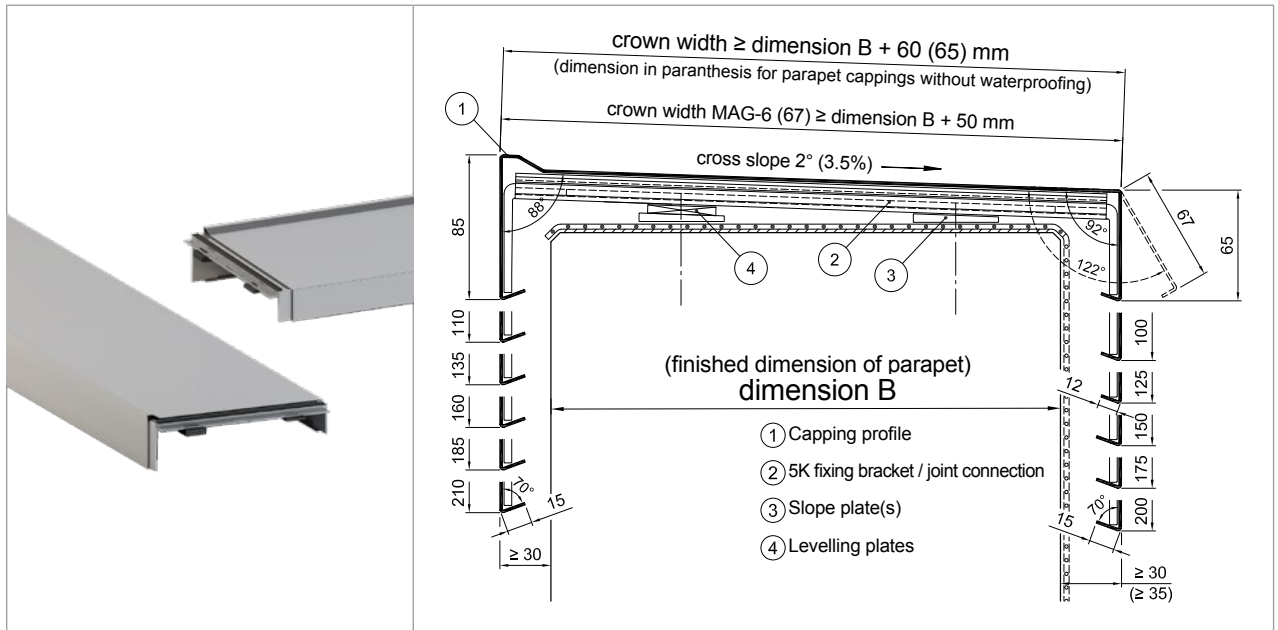

Standard fixing bracket distance (up to crown width 400 mm: 1.25 m, crown width 405 – 750 mm: 1.00 m)

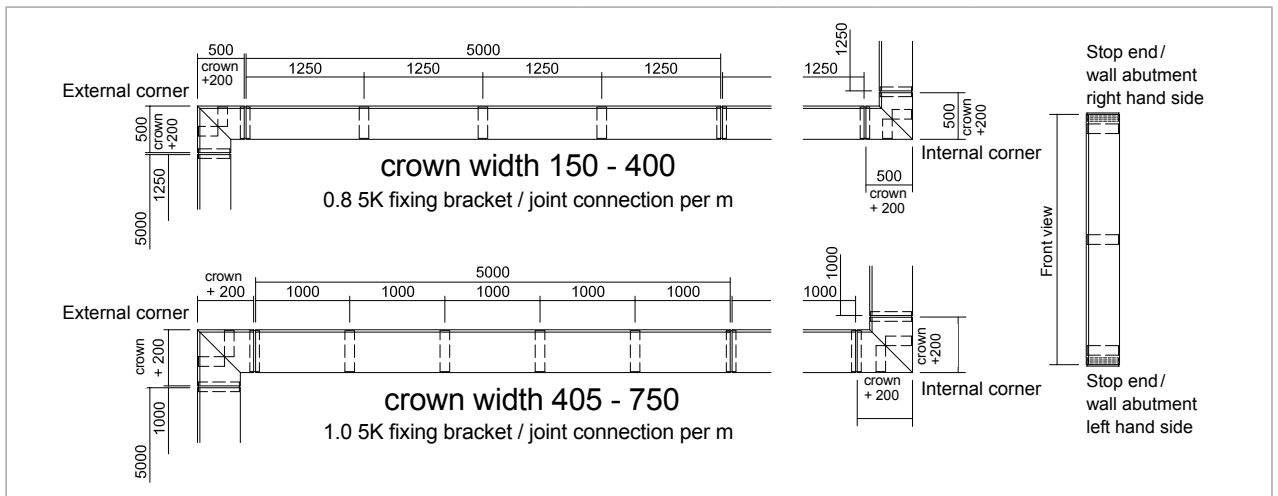

Maximum building heights for standard fixing bracket distance depending on wind load zone and terrain category according to DIN EN 1991-1-4 (Eurocode), material thickness and crown width

| Material thickness in mm | 1.5 | | | | | | 2.0 | | | | | |
|--|----------------------|------|------|------|------|-------|-------|------|------|-------|--------|--------|
| | 250 | 300 | 350 | 400 | 450 | 500 | 550 | 600 | 650 | 700 | 750 | |
| max. building height in wind load zone 1 | Terrain category II | 25 m | 25 m | 25 m | 25 m | 18 m | 7 m | 25 m | 24 m | 18 m | 13 m | 7.5 m |
| | Mixed profile inland | 25 m | 25 m | 25 m | 25 m | 25 m | 14 m | 25 m | 25 m | 25 m | 20 m | 15 m |
| | Terrain category III | 25 m | 25 m | 25 m | 25 m | 25 m | 19 m | 25 m | 25 m | 25 m | 25 m | 20 m |
| max. building height in wind load zone 2 | Terrain category II | 25 m | 25 m | 25 m | 21 m | 7.5 m | - | 15 m | 10 m | 7.5 m | 6 m | - |
| | Mixed profile inland | 25 m | 25 m | 25 m | 25 m | 15 m | 8.5 m | 23 m | 18 m | 15 m | 12 m | 9 m |
| | Terrain category III | 25 m | 25 m | 25 m | 25 m | 20 m | 10 m | 25 m | 25 m | 19 m | 15.5 m | 10.5 m |
| max. building height in wind load zone 3 | Mixed profile inland | 25 m | 25 m | 25 m | 18 m | 9 m | - | 14 m | 11 m | 9 m | 7 m | - |
| | Terrain category III | 25 m | 25 m | 25 m | 23 m | 11 m | - | 18 m | 14 m | 11 m | 8 m | - |

In case of different building heights and wind-exposed areas (e.g. wind load zone 4, coastal proximity, building locations > 800 m above sea level, exposed position) additional fixing brackets are required.

MAG-6

Wall capping profile MAG-6

Front face height: 85, 110, 135, 160, 185, 210 mm - Back face height: 67, 65, 100, 125, 150, 175, 200 mm

| Girth up to (crown width 150 mm – max. 750 mm) mm | Mill finish protection foiled ¹ incl. 5K fixing bracket/joint connection for standard fixing bracket distance | | Surcharge colour coating ² €/m | Stop end/ wall abutment mill finish €/piece | 90° corner surcharge ³ mill finish incl. acc. €/piece | Surcharge colour coating corner/stop end/ wall abutment €/piece | Additional demand 5K fixing bracket/ joint connection €/piece |
|---|---|--------|--|--|--|---|---|
| | €/m | €/m | | | | | |
| | 1.5 mm | 2.0 mm | | | | | |
| 300 | 43.60 | 50.45 | 17.45 | 35.25 | 88.10 | 9.20 | 15.85 |
| 325 | 45.70 | 53.10 | 18.90 | 37.60 | 90.55 | 9.60 | 16.25 |
| 350 | 47.80 | 55.75 | 20.35 | 39.95 | 93.00 | 10.00 | 16.65 |
| 375 | 49.90 | 58.40 | 21.80 | 42.30 | 95.45 | 10.40 | 17.05 |
| 400 | 52.00 | 61.05 | 23.25 | 44.65 | 97.90 | 10.80 | 17.45 |
| 425 | 54.10 | 63.70 | 24.70 | 47.00 | 100.35 | 11.20 | 17.85 |
| 450 | 56.20 | 66.35 | 26.15 | 49.35 | 102.80 | 11.60 | 18.25 |
| 475 | 58.30 | 69.00 | 27.60 | 51.70 | 105.25 | 12.00 | 18.65 |
| 500 | 60.40 | 71.65 | 29.05 | 54.05 | 107.70 | 12.40 | 19.05 |
| 525 | 62.50 | 74.30 | 30.50 | 56.40 | 110.15 | 12.80 | 19.45 |
| 550 | 64.60 | 76.95 | 31.95 | 58.75 | 112.60 | 13.20 | 19.85 |
| 575 | 70.75 | 83.65 | 33.40 | 61.10 | 115.05 | 13.60 | 20.25 |
| 600 | 72.85 | 86.30 | 34.85 | 63.45 | 117.50 | 14.00 | 20.65 |
| 625 | 74.95 | 88.95 | 36.30 | 65.80 | 119.95 | 14.40 | 21.05 |
| 650 | 77.05 | 91.60 | 37.75 | 68.15 | 122.40 | 14.80 | 21.45 |
| 675 | 79.15 | 94.25 | 39.20 | 70.50 | 124.85 | 15.20 | 21.85 |
| 700 | 81.25 | 96.90 | 40.65 | 72.85 | 127.30 | 15.60 | 22.25 |
| 725 | 83.35 | 99.55 | 42.10 | 75.20 | 129.75 | 16.00 | 22.65 |
| 750 | 85.45 | 102.20 | 43.55 | 77.55 | 132.20 | 16.40 | 23.05 |
| 775 | - | 104.85 | 45.00 | 79.90 | 134.65 | 16.80 | 23.45 |
| 800 | - | 107.50 | 46.45 | 82.25 | 137.10 | 17.20 | 23.85 |
| 825 | - | 110.15 | 47.90 | 84.60 | 139.55 | 17.60 | 24.25 |
| 850 | - | 112.80 | 49.35 | 86.95 | 142.00 | 18.00 | 24.65 |
| 875 | - | 115.45 | 50.80 | 89.30 | 144.45 | 18.40 | 25.05 |
| 900 | - | 118.10 | 52.25 | 91.65 | 146.90 | 18.80 | 25.45 |
| 925 | - | 120.75 | 53.70 | 94.00 | 149.35 | 19.20 | 25.85 |
| 950 | - | 123.40 | 55.15 | 96.35 | 151.80 | 19.60 | 26.25 |
| 975 | - | 126.05 | 56.60 | 98.70 | 154.25 | 20.00 | 26.65 |
| 1,000 | - | 128.70 | 58.05 | 101.05 | 156.70 | 20.40 | 27.05 |

Crown widths selectable in intervals of 5 mm

Crown widths 150 up to 500 mm in 1.5 and 2.0 mm thick aluminium sheet

Crown widths > 500 up to 750 mm in 2.0 mm thick aluminium sheet

Deviant front face heights / back face heights / crown widths / sheet thicknesses on request

Order information: MAG-6 crown width / front face height / back face height / sheet thickness

Scope of delivery MAG-6

per m profile

per 90° external corner resp. per 90° internal corner

0.2 bars wall capping profile at 5.00 m

0.8 5K fixing brackets / joint connection (crown width up to 400 mm)
1.0 5K fixing bracket / joint connection (crown width 405 up to 750 mm)
Slope plates, levelling plates

Capping external corner resp. capping internal corner
- for crown width up to 300 mm: corner leg length = 500 mm
- for crown width > 300 mm: corner leg length = crown width + 200 mm
1 5K fixing bracket / joint connection
2 5K corner fixing brackets (front face resp. back face)
Slope plates, levelling plates

In case of different building heights and wind-exposed areas (e.g. wind load zone 4, coastal proximity, building locations > 800 m above sea level, exposed position) additional fixing brackets are required.

Surcharge

€/bag

Levelling plates (bag at 50 pieces)

25.00

¹ Surcharge for special lengths: For bars shorter than the standard bar lengths, a surcharge of 20 % of the profile price per meter will be charged

² Prices are only valid for the colour category "alwitra select" (for further information see pages 56-59)

³ "Surcharge for corner" only for offers according to tenders. In case of order the prices for "complete corners incl. accessories" will be invoiced.

MAG-5

Wall capping profile MAG-5

Front face height = Back face height: 67, 65, 100, 125, 150, 175, 200 mm

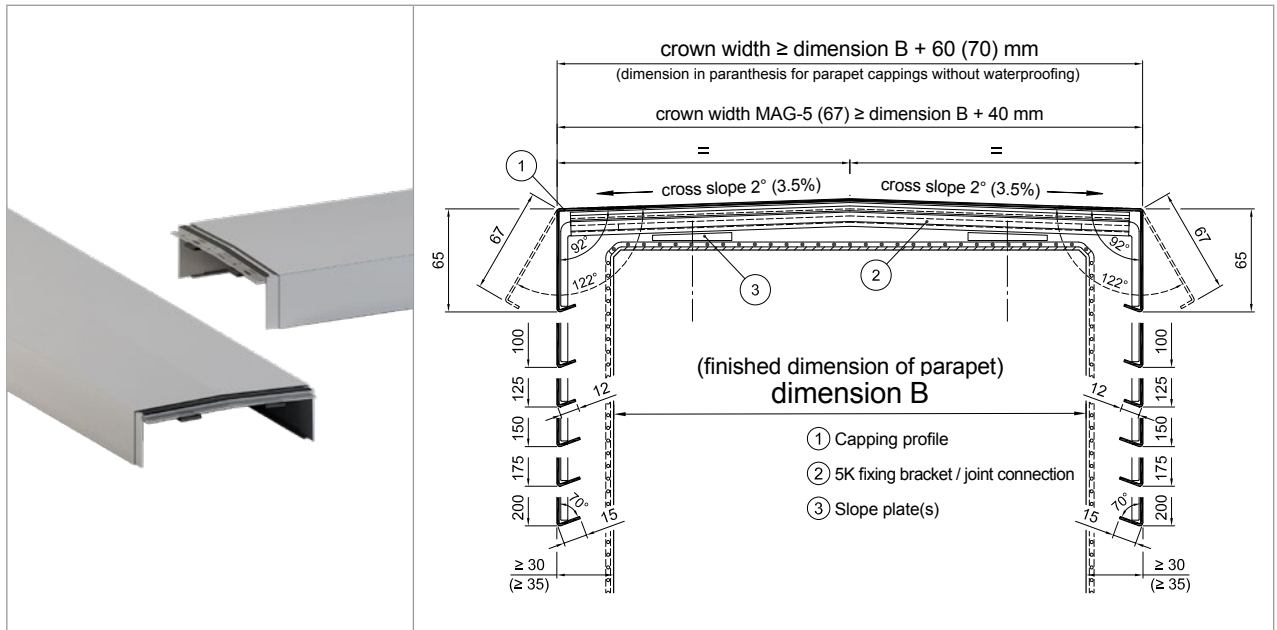

Standard fixing bracket distance (up to crown width 400 mm: 1.25 m, crown width 410 – 750 mm: 1.00 m)

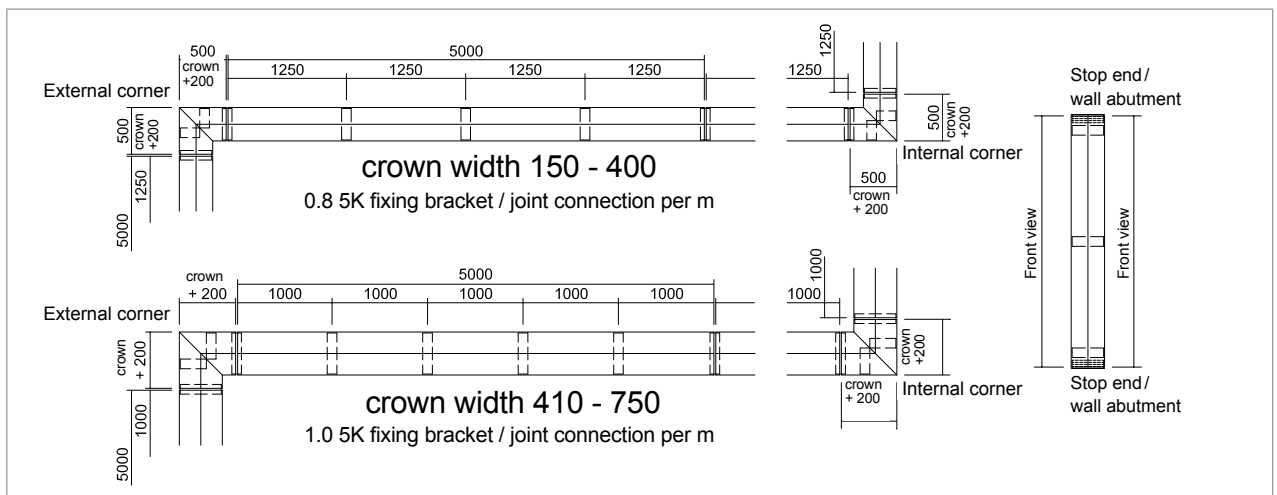

Maximum building heights for standard fixing bracket distance depending on wind load zone and terrain category according to DIN EN 1991-1-4 (Eurocode), material thickness and crown width

| Material thickness in mm | 1.5 | | | | | | 2.0 | | | | | |
|--|----------------------|------|------|------|------|-------|-------|------|------|-------|--------|--------|
| | 250 | 300 | 350 | 400 | 450 | 500 | 550 | 600 | 650 | 700 | 750 | |
| max. building height in wind load zone 1 | Terrain category II | 25 m | 25 m | 25 m | 25 m | 18 m | 7 m | 25 m | 24 m | 18 m | 13 m | 7.5 m |
| | Mixed profile inland | 25 m | 25 m | 25 m | 25 m | 25 m | 14 m | 25 m | 25 m | 25 m | 20 m | 15 m |
| | Terrain category III | 25 m | 25 m | 25 m | 25 m | 25 m | 19 m | 25 m | 25 m | 25 m | 25 m | 20 m |
| max. building height in wind load zone 2 | Terrain category II | 25 m | 25 m | 25 m | 21 m | 7.5 m | - | 15 m | 10 m | 7.5 m | 6 m | - |
| | Mixed profile inland | 25 m | 25 m | 25 m | 25 m | 15 m | 8.5 m | 23 m | 18 m | 15 m | 12 m | 9 m |
| | Terrain category III | 25 m | 25 m | 25 m | 25 m | 20 m | 10 m | 25 m | 25 m | 19 m | 15.5 m | 10.5 m |
| max. building height in wind load zone 3 | Mixed profile inland | 25 m | 25 m | 25 m | 18 m | 9 m | - | 14 m | 11 m | 9 m | 7 m | - |
| | Terrain category III | 25 m | 25 m | 25 m | 23 m | 11 m | - | 18 m | 14 m | 11 m | 8 m | - |

In case of different building heights and wind-exposed areas (e.g. wind load zone 4, coastal proximity, building locations > 800 m above sea level, exposed position) additional fixing brackets are required.

MAG-5

Wall capping profile MAG-5

Front face height = Back face height: 67, 65, 100, 125, 150, 175, 200 mm

| Girth up to (crown width 150 mm – max. 750 mm) mm | Mill finish protection foiled ¹ incl. 5K fixing bracket/joint connection for standard fixing bracket distance | | Surcharge colour coating ² €/m | Stop end/ wall abutment mill finish €/piece | 90° corner surcharge ³ mill finish €/piece | Surcharge colour coating corner/stop end/ wall abutment €/piece | Additional demand 5K fixing bracket/ joint connection €/piece |
|---|---|--------|--|--|--|---|---|
| | €/m | | | | | | |
| | 1.5 mm | 2.0 mm | | | | | |
| 250 | 42.80 | 48.55 | 14.55 | 33.30 | 83.20 | 8.40 | 17.80 |
| 275 | 44.90 | 51.20 | 16.00 | 35.65 | 85.65 | 8.80 | 18.20 |
| 300 | 47.00 | 53.85 | 17.45 | 38.00 | 88.10 | 9.20 | 18.60 |
| 325 | 49.10 | 56.50 | 18.90 | 40.35 | 90.55 | 9.60 | 19.00 |
| 350 | 51.20 | 59.15 | 20.35 | 42.70 | 93.00 | 10.00 | 19.40 |
| 375 | 53.30 | 61.80 | 21.80 | 45.05 | 95.45 | 10.40 | 19.80 |
| 400 | 55.40 | 64.45 | 23.25 | 47.40 | 97.90 | 10.80 | 20.20 |
| 425 | 57.50 | 67.10 | 24.70 | 49.75 | 100.35 | 11.20 | 20.60 |
| 450 | 59.60 | 69.75 | 26.15 | 52.10 | 102.80 | 11.60 | 21.00 |
| 475 | 61.70 | 72.40 | 27.60 | 54.45 | 105.25 | 12.00 | 21.40 |
| 500 | 63.80 | 75.05 | 29.05 | 56.80 | 107.70 | 12.40 | 21.80 |
| 525 | 65.90 | 77.70 | 30.50 | 59.15 | 110.15 | 12.80 | 22.20 |
| 550 | 68.00 | 80.35 | 31.95 | 61.50 | 112.60 | 13.20 | 22.60 |
| 575 | 73.85 | 86.75 | 33.40 | 63.85 | 115.05 | 13.60 | 23.00 |
| 600 | 75.95 | 89.40 | 34.85 | 66.20 | 117.50 | 14.00 | 23.40 |
| 625 | 78.05 | 92.05 | 36.30 | 68.55 | 119.95 | 14.40 | 23.80 |
| 650 | 80.15 | 94.70 | 37.75 | 70.90 | 122.40 | 14.80 | 24.20 |
| 675 | 82.25 | 97.35 | 39.20 | 73.25 | 124.85 | 15.20 | 24.60 |
| 700 | 84.35 | 100.00 | 40.65 | 75.60 | 127.30 | 15.60 | 25.00 |
| 725 | 86.45 | 102.65 | 42.10 | 77.95 | 129.75 | 16.00 | 25.40 |
| 750 | 88.55 | 105.30 | 43.55 | 80.30 | 132.20 | 16.40 | 25.80 |
| 775 | - | 107.95 | 45.00 | 82.65 | 134.65 | 16.80 | 26.20 |
| 800 | - | 110.60 | 46.45 | 85.00 | 137.10 | 17.20 | 26.60 |
| 825 | - | 113.25 | 47.90 | 87.35 | 139.55 | 17.60 | 27.00 |
| 850 | - | 115.90 | 49.35 | 89.70 | 142.00 | 18.00 | 27.40 |
| 875 | - | 118.55 | 50.80 | 92.05 | 144.45 | 18.40 | 27.80 |
| 900 | - | 121.20 | 52.25 | 94.40 | 146.90 | 18.80 | 28.20 |
| 925 | - | 123.85 | 53.70 | 96.75 | 149.35 | 19.20 | 28.60 |
| 950 | - | 126.50 | 55.15 | 99.10 | 151.80 | 19.60 | 29.00 |
| 975 | - | 129.15 | 56.60 | 101.45 | 154.25 | 20.00 | 29.40 |
| 1,000 | - | 131.80 | 58.05 | 103.80 | 156.70 | 20.40 | 29.80 |

Crown widths selectable in intervals of 10 mm

Crown widths 150 up to 500 mm in 1.5 and 2.0 mm thick aluminium sheet

Crown widths > 500 up to 750 mm in 2.0 mm thick aluminium sheet

Deviant front face heights / back face heights / crown widths / sheet thicknesses on request

Order information: MAG-5 crown width / front face height / sheet thickness

Scope of delivery MAG-5

per m profile

per 90° external corner resp. per 90° internal corner

0.2 bars wall capping profile at 5.00 m

0.8 5K fixing brackets / joint connection (crown width up to 400 mm)

1.0 5K fixing bracket / joint connection (crown width 410 up to 750 mm)

Slope plates, levelling plates

Capping external corner resp. capping internal corner

- for crown width up to 300 mm: corner leg length = 500 mm

- for crown width > 300 mm: corner leg length = crown width + 200 mm

1 5K fixing bracket / joint connection

2 5K corner fixing brackets (front face resp. back face)

Slope plates, levelling plates

In case of different building heights and wind-exposed areas (e.g. wind load zone 4, coastal proximity, building locations > 800 m above sea level, exposed position) additional fixing brackets are required.

Surcharge

€/bag

Levelling plates (bag at 50 pieces)

25.00

¹ Surcharge for special lengths: For bars shorter than the standard bar lengths, a surcharge of 20 % of the profile price per meter will be charged

² Prices are only valid for the colour category "alwitra select" (for further information see pages 56-59)

³ "Surcharge for corner" only for offers according to tenders. In case of order the prices for "complete corners incl. accessories" will be invoiced.

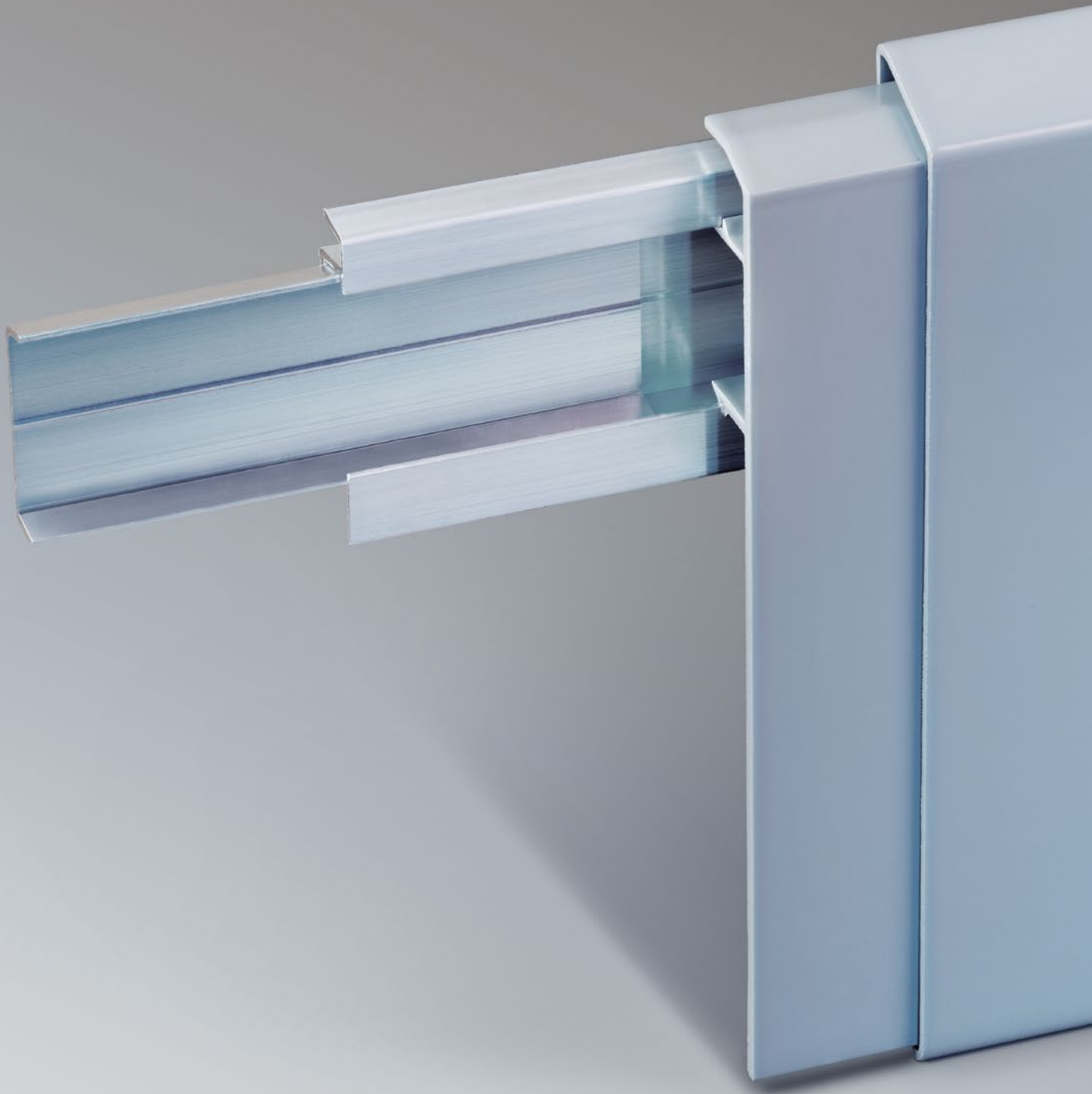

Wall flashing profiles

Wall flashing profile WA 1

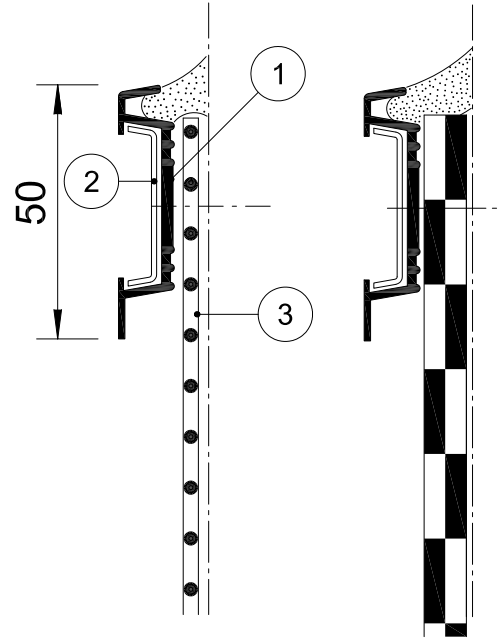
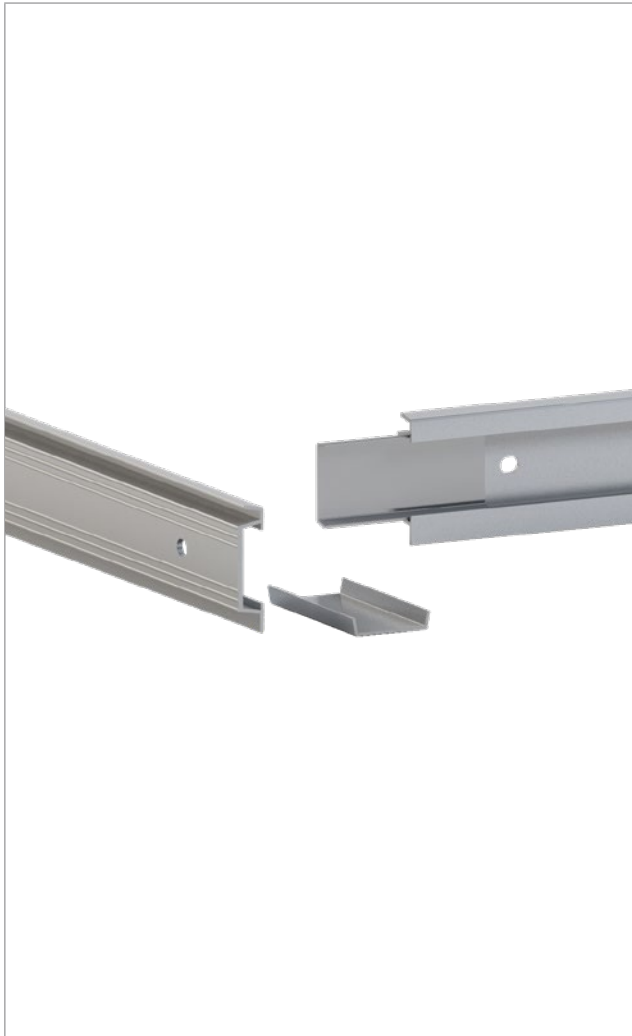

- ① Wall flashing profile WA 1
- ② Joint connection
- ③ Tape

WA 1

Wall flashing profile WA 1

| Profile nominal height | Packing unit | Mill finish ¹ incl. acc. | 90° corner complete mill finish | 90° corner surcharge ² mill finish |
|------------------------|--------------|--|---------------------------------------|---|
| mm | bars x m | €/m | €/piece | €/piece |
| 50 | 33 x 3 | 6.30 | 7.90 | 5.50 |

Scope of delivery WA 1

| per m profile | per 90° corner |
|---|--|
| 0.33 bars WA 1 profile at 3.00 m, perforated 6.5 x 8 mm in e = 192 mm 0.33 joint connection | adjustable wall flashing corner (19/19 cm), perforated 6.5 x 8 mm 2 joint connection |

Prefabricated pieces type W

| | Product | Colour | €/piece |
|---|-------------------------------------|--|-------------|
|  | Internal corner for parapets | EVALON® white / light grey / slate grey | 8.65 |
| | | EVALASTIC® light grey / slate grey matt | 8.65 |
|  | External corner for parapets | EVALON® white / light grey / slate grey | 8.65 |
| | | EVALASTIC® light grey / slate grey matt | 8.65 |

¹ Surcharge for special lengths: For bars shorter than the standard bar lengths, a surcharge of 20 % of the profile price per meter will be charged

² "Surcharge for corner" only for offers according to tenders. In case of order the prices for "complete corners incl. accessories" will be invoiced.

Wall flashing profile WA 150

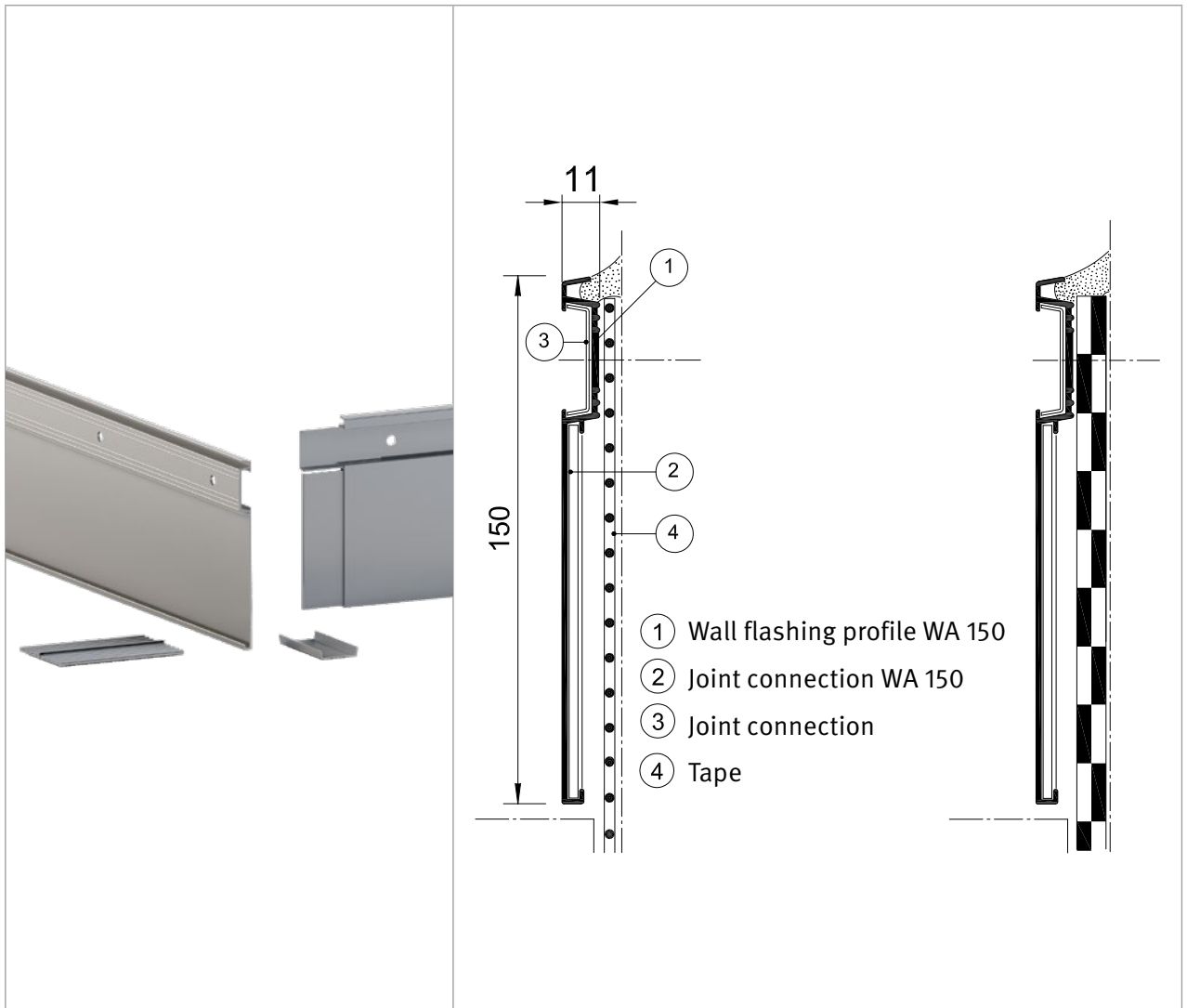

WA 150

Wall flashing profile WA 150

| Profile nominal height | Packing unit | Mill finish ¹ incl. acc. | Surcharge colour coating ² | 90° corner complete mill finish | Surcharge colour coating corner complete | Closed stop end mill finish | 90° corner surcharge ³ mill finish | Surcharge colour coating stop end/ corner surcharge ³ | Additional demand fixing bracket/ joint-connection |
|------------------------|--------------|-------------------------------------|---------------------------------------|---------------------------------|--|-----------------------------|---|--|--|
| mm | bars x m | €/m | €/m | €/piece | €/piece | €/piece | €/piece | €/piece | €/piece |
| 150 | 20 x 3 | 17.45 | 13.00 | 22.15 | 10.65 | 27.15 | 15.50 | 5.70 | 2.25 |

Scope of delivery WA 150

| per m profile | per 90° corner |
|---|--|
| 0.33 bars WA 150 profile at 3.00 m, perforated Ø 8.5 mm in e = 192 mm, 0.33 joint connection 0.33 joint connection WA 150 | Wall flashing corner (19/19 cm), perforated Ø 8.5 mm 2 joint connection WA 1 2 joint connection WA 150 |

Prefabricated pieces type W

| | Product | Colour | €/piece |
|---|-------------------------------------|--|-------------|
|  | Internal corner for parapets | EVALON® white / light grey / slate grey | 8.65 |
| | | EVALASTIC® light grey / slate grey matt | 8.65 |
|  | External corner for parapets | EVALON® white / light grey / slate grey | 8.65 |
| | | EVALASTIC® light grey / slate grey matt | 8.65 |

¹ Surcharge for special lengths: For bars shorter than the standard bar lengths, a surcharge of 20 % of the profile price per meter will be charged

² Prices are only valid for the colour category "alwitra select" (for further information see pages 56-59)

³ "Surcharge for corner" only for offers according to tenders. In case of order the prices for "complete corners incl. accessories" will be invoiced.

Wall flashing profile WA 1 - ÜK

Profile nominal height: 150, 175, 200, 225, 250 or 275 mm

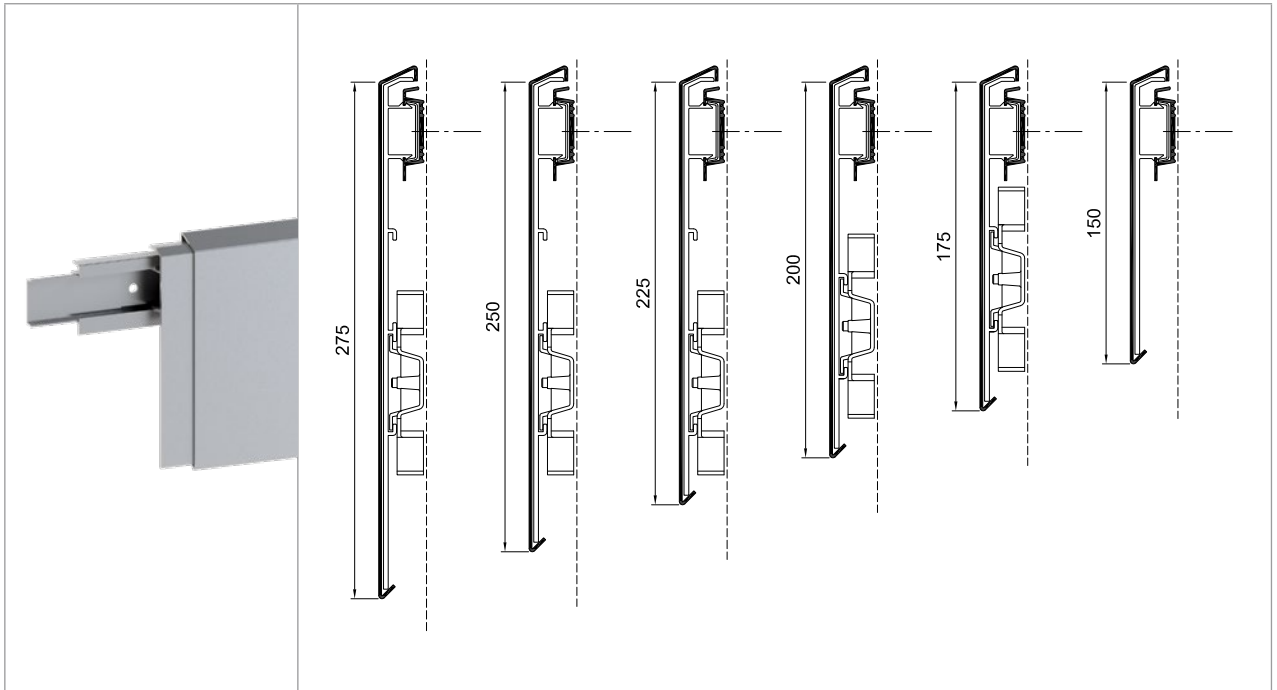

Wall flashing profile WA 1 - ÜK

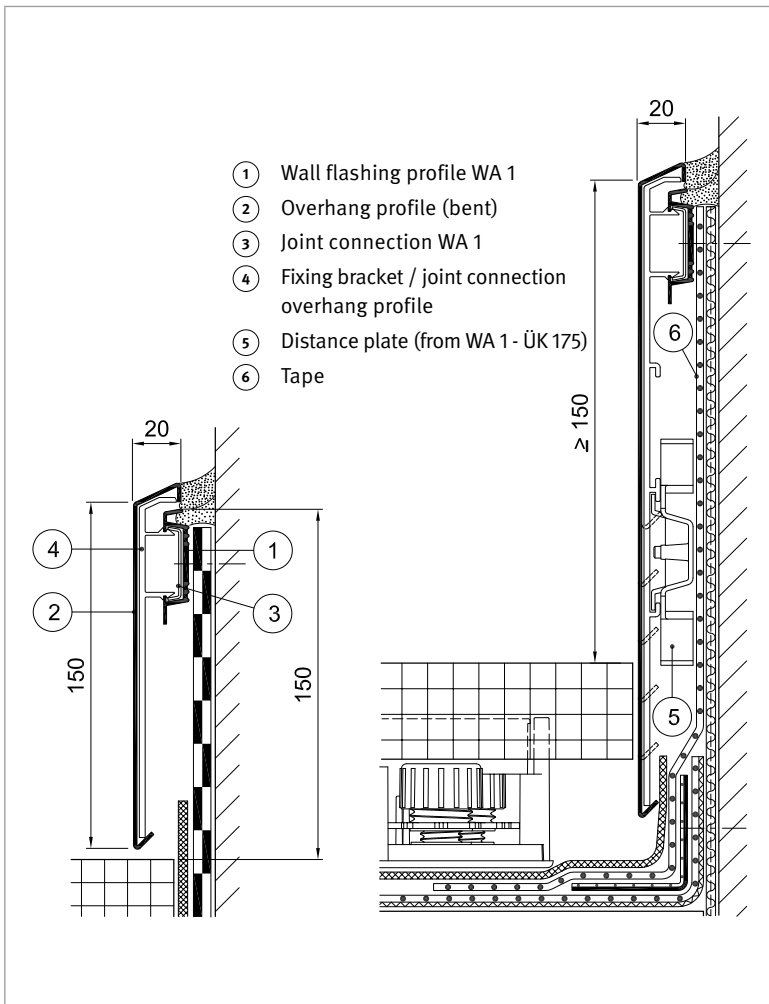

Arrangement of fixing brackets

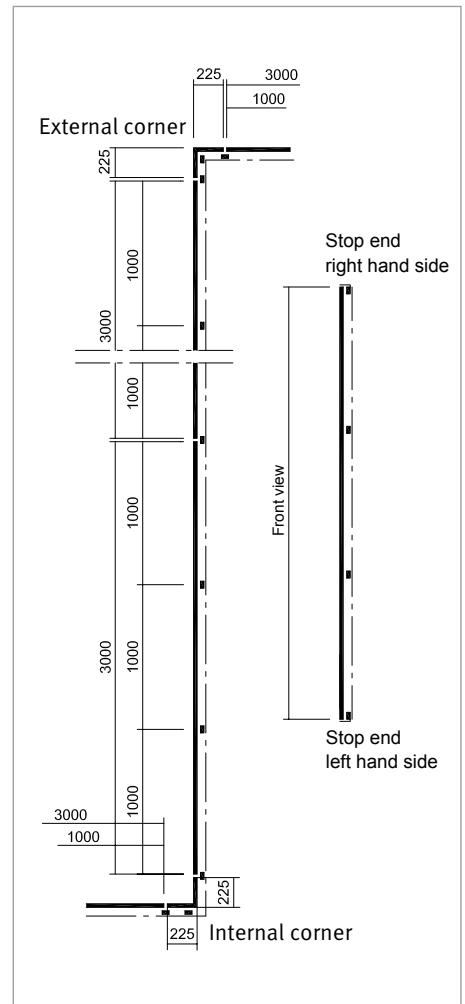

Wall flashing profile WA 1 - ÜK with covered fastening

| Profile nominal height | Packing unit | Mill finish ¹ incl. acc. | Surcharge colour coating ² | 90° corner complete mill finish incl. acc. | Surcharge colour coating corner complete | Closed stop end mill finish | 90° corner surcharge ³ mill finish incl. acc. | Surcharge colour coating stop end/corner surcharge ³ | Additional demand fixing bracket/joint-connection |
|------------------------|--------------|-------------------------------------|---------------------------------------|--|--|-----------------------------|--|---|---|
| mm | bars x m | €/m | €/m | €/piece | €/piece | €/piece | €/piece | €/piece | €/piece |
| 150 | 20 x 3 | 27.10 | 12.95 | 51.05 | 11.55 | 28.35 | 38.85 | 5.70 | 2.75 |
| 175 | 20 x 3 | 33.55 | 14.55 | 55.25 | 12.25 | 28.35 | 40.15 | 5.70 | 3.65 |
| 200 | 20 x 3 | 35.10 | 16.25 | 56.70 | 13.05 | 28.35 | 40.90 | 5.70 | 3.75 |
| 225 | 20 x 3 | 36.70 | 17.90 | 58.10 | 13.80 | 30.65 | 41.55 | 5.70 | 3.90 |
| 250 | 20 x 3 | 38.00 | 19.60 | 59.60 | 14.55 | 32.85 | 42.50 | 5.70 | 4.05 |
| 275 | 20 x 3 | 39.45 | 21.35 | 60.85 | 15.35 | 35.20 | 43.05 | 5.70 | 4.20 |



Scope of delivery WA 1 - ÜK

| per m profile | per 90° corner |
|--|--|
| 0.33 bars WA 1 profile at 3.00 m, perforated 6.5 x 8 mm in e = 192 mm 0.33 joint connection WA 1 0.33 bars overhang profile at 3.00 m 1 fixing bracket/joint connection for overhang profiles 1 distance plate (for WA 1 - ÜK 175) | Wall flashing corner (19/19 cm), perforated 6.5 x 8 mm 2 joint connection WA 1 Overhang profile corner (22.5/22.5 cm) 2 fixing brackets/joint connections for overhang profiles 2 distance plate (for WA 1 - ÜK 175) |

Tapes

| | Width | EVALON® 1.5 mm, homogeneous | EVALASTIC® 1.5 mm, homogeneous | EVALON® VSKA 1.5 mm | EVALASTIC® VSKA 1.5 mm |
|---------------------------|-------|--------------------------------|-----------------------------------|------------------------|---------------------------|
| | cm | €/m | €/m | €/m | €/m |
| Tape | 33 | 9.80 | 9.75 | - | - |
| | 50 | 14.65 | 14.60 | - | - |
| Self-adhesive tape | 33 | - | - | 12.25 | 12.60 |
| | 43 | - | - | 15.85 | 16.05 |

Prefabricated pieces type W

| Form | Product | Colour | €/piece |
|---|-------------------------------------|--|---------|
|  | Internal corner for parapets | EVALON® white / light grey / slate grey | 8.65 |
| | | EVALASTIC® light grey / slate grey matt | 8.65 |
|  | External corner for parapets | EVALON® white / light grey / slate grey | 8.65 |
| | | EVALASTIC® light grey / slate grey matt | 8.65 |

¹ Surcharge for special lengths: For bars shorter than the standard bar lengths, a surcharge of 20 % of the profile price per meter will be charged

² Prices are only valid for the colour category "alwitra select" (for further information see pages 56-59)

³ "Surcharge for corner" only for offers according to tenders. In case of order the prices for "complete corners incl. accessories" will be invoiced.



Colour coating



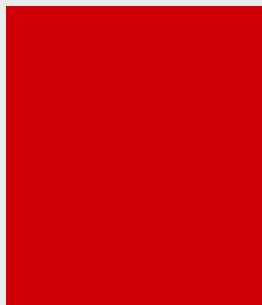

RAL 3020 traffic red
gloss, matt

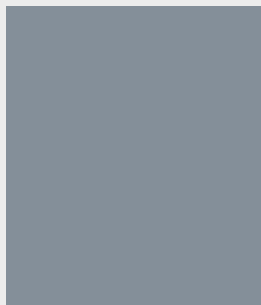

RAL 7001 silver grey
gloss, satin-gloss



RAL 7004 signal grey
gloss, matt

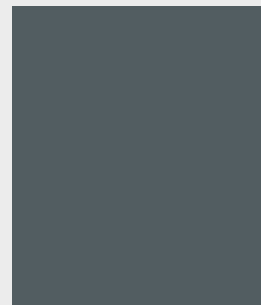

RAL 7012 basalt grey
gloss, satin-gloss

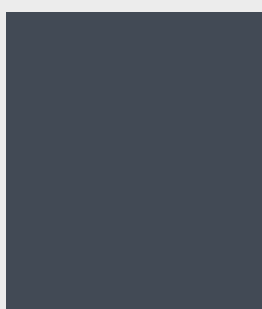

RAL 7015 slate grey
gloss, satin-gloss

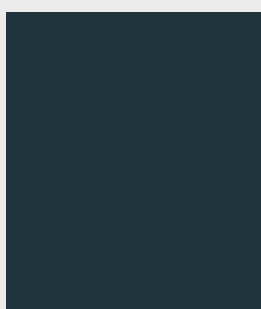

RAL 7016 anthracite grey
gloss, satin-gloss

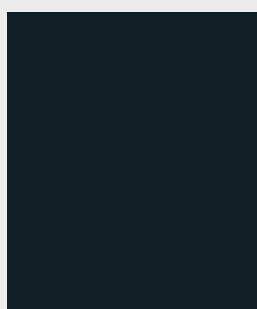

RAL 7021 black grey
gloss, satin-gloss



RAL 7022 umber
gloss, matt

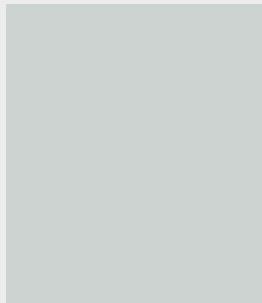

RAL 7035 light grey
gloss, satin-gloss

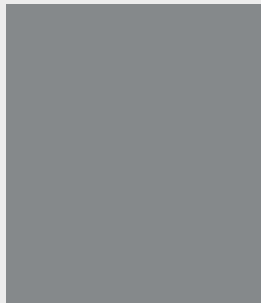

RAL 7037 dusty grey
gloss, satin-gloss



RAL 7039 quartz grey
gloss, matt

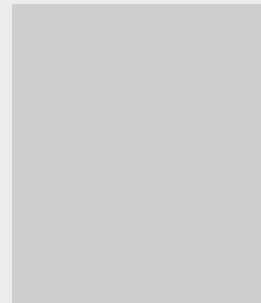

RAL 7047 telegrey 4
gloss, satin-gloss

The samples are printed versions of the original colours. Deviations in colour and gloss level reserved.

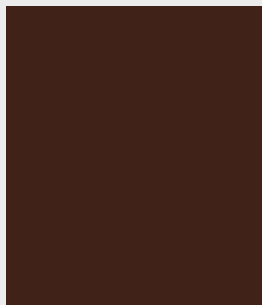

RAL 8017 chocolate brown
gloss, satin-gloss

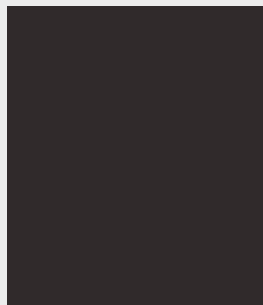

RAL 8019 grey brown
gloss, satin-gloss



RAL 9005 jet black
gloss, satin-gloss

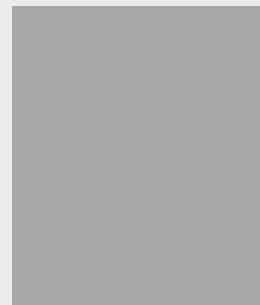

RAL 9006 white aluminium
Structure, matt, metallic

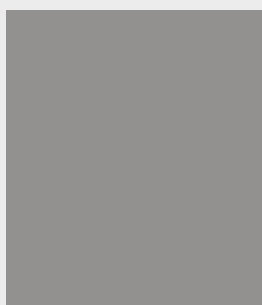

RAL 9007 grey aluminium
Structure, matt, metallic

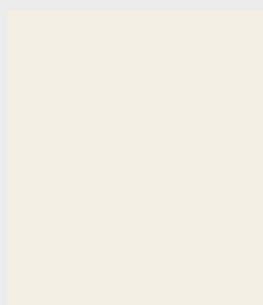

RAL 9010 pure white
gloss, satin-gloss

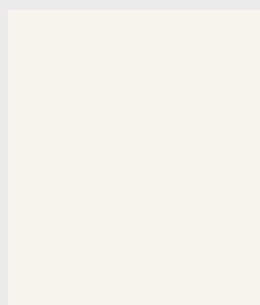

RAL 9016 traffic white
gloss, satin-gloss

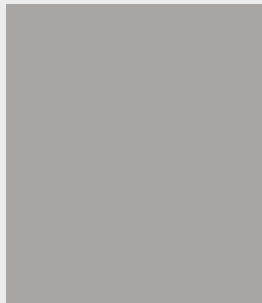

DB 701
Structure, matt, metallic

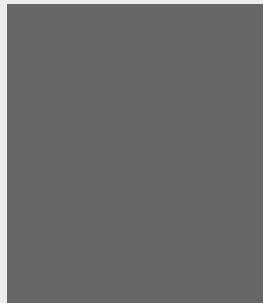

DB 702
Structure, matt, metallic



DB 703
Structure, matt, metallic

The samples are printed versions of the original colours. Deviations in colour and gloss level reserved.

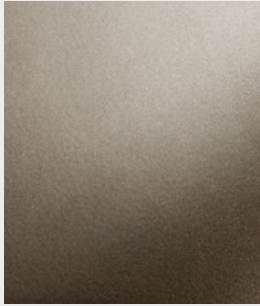

anodized effect C34
gloss, matt, metallic

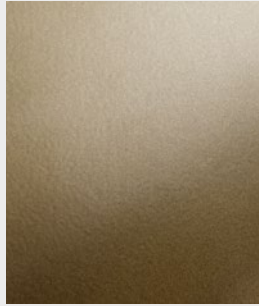

anodized effect C33
gloss, matt, metallic



anodized effect C32
gloss, matt, metallic

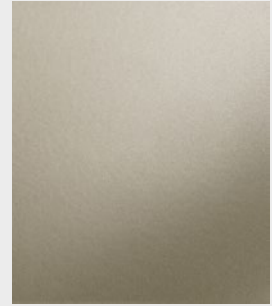

anodized effect C31
gloss, matt, metallic



anodized effect C0
gloss, matt, metallic

The samples are printed versions of the original colours. Deviations in colour and gloss level reserved.

Colour coating

Colour coating

With **alwitra select** and **alwitra select plus**, we offer you the latest colours and surface effects for modern roof edge design in highly weather-resistant quality (HWF, GSB-Master). All other colours from the RAL CLASSIC colour range are available in facade quality (GSB-Standard).

For further information see www.alwitra.de/en/aluminium-profiles/synthetic-coatings

The billing of this colour category will be done according to the valid price list. The minimum coating values per colour and delivery are:

- **alwitra select:** minimum lump-sum for colour coating: 150.00 € gross.
- **alwitra select plus:** The billing will be done according to the valid price list for the colour category „alwitra select” plus a surcharge of 25%. The minimum lump-sum for colour coating amounts 550.00 € gross.
- **Other colours RAL CLASSIC:** All other colours of the RAL CLASSIC colour range are generally available only in the facade quality "GSB Standard" (not highly weatherproof). The billing will be done according to the valid price list for the colour category „alwitra select” plus a surcharge of 10%. The minimum coating value for other colours of the RAL CLASSIC colour range amounts: 300.00 € gross.
Not available are e.g. fluorescent colours (RAL 1026, 2005, 2007, 3024, 3026).
- **Special colours,** that deviate from the RAL CLASSIC colour range, are – if deliverable – carried out by alwitra solely after a project-related testing and approval at extra cost.

Daylight systems



Rooflight

Form/ Product specification

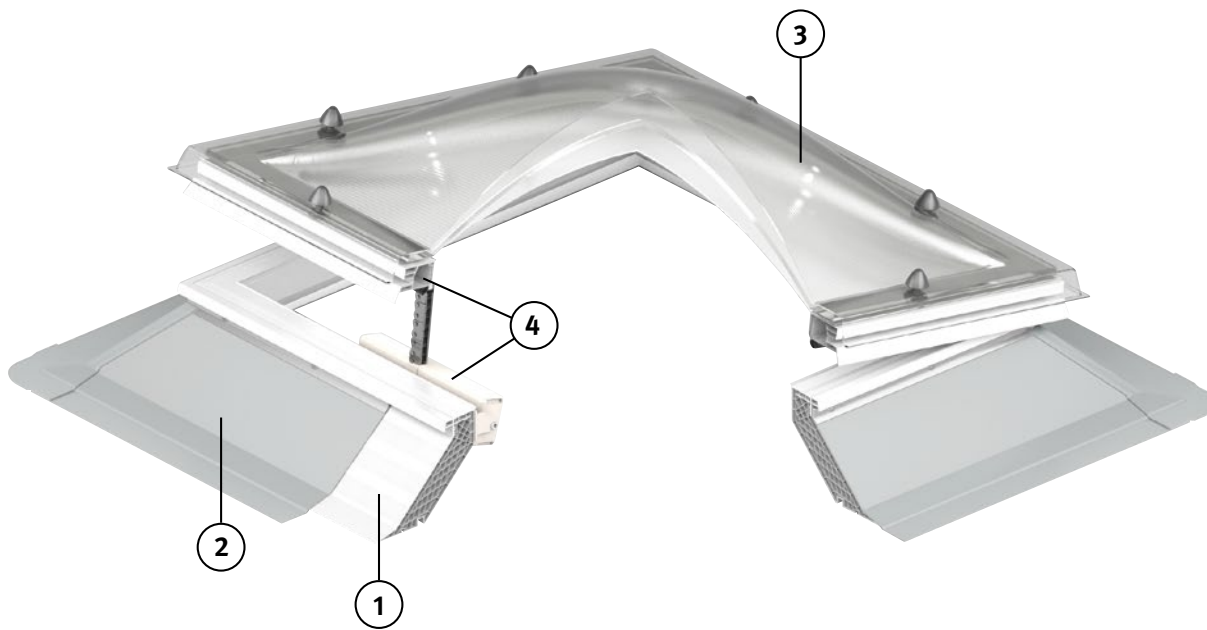

① Kerb

② factory-fitted flashing collar

③ Rooflight or DayLuxe window 2.0 rigid

Options (not visualized):

③a DayLuxe window 2.0 ventilated with integrated drive

④ Opening system (optional)

④a Opening system for daily ventilation incl. vent frame

Options (not visualized):

④b Roof hatch, if applicable in combination with opening system for daily ventilation incl. vent frame





④c Vent frame (lockable) as single component

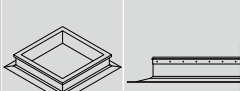
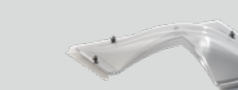

Price fixing for alwitra rooflights

Explanation of the price fixing for alwitra rooflight (page 64/65) and alwitra DayLuxe windows 2.0 (page 67)

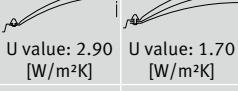
| No. | Product | Price € |
|-----------------------|---|---------|
| 1 | Kerb | _____ € |
| 2 | + factory-fitted flashing collar (optional) | _____ € |
| 3 | + Rooflight or DayLuxe window 2.0 rigid | _____ € |
| | or | |
| 3a | DayLuxe window 2.0 ventilated with integrated drive | |
| 4 | + Opening system (optional) | _____ € |
| 4a | for daily ventilation by using a spindle or motor opener incl. vent frame | |
| | or | |
| 4b | Roof hatch, if applicable in combination with opening system for daily ventilation incl. vent frame | |
| | or | |
| 4c | Vent frame as single component, e.g. for retrofitting. A spindle opener, motor opener or roof hatch is additionally required. | |
| = Total amount | | _____ € |

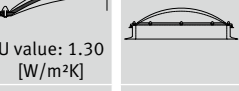
alwitra Rooflights and Kerbs

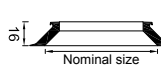
| Product | Nominal size ¹ = roof opening size | Kerb ² | | Rooflight ³ | | | Complete rigid (Kerb + Rooflight) | | |
|---------|---|---|---|---|---|---|--|--|--|
| | |  |  |  |  |  |  |  |  |
| | | Kerb | factory-fitted flashing collar EVALON®/EVALASTIC® | U value: 2.90 [W/m²K] 2S PMMA ⁴ opal | U value: 1.70 [W/m²K] 3S PMMA ⁴ opal | U value: 1.30 [W/m²K] 2S WD ⁵ opal | Kerb + 2S rigid | Kerb + 3S rigid | Kerb + 2S WD rigid |
| | | €/piece | €/piece | €/piece | €/piece | €/piece | €/piece | €/piece | €/piece |

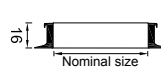
| | | ① | ② | ③ | | | ① + ③ | | |
|--|---------|--------|--------|----------|----------|----------|----------|----------|----------|
| Kerb 1620 Height 16 cm, U value: 0.92 [W/m²K] Nominal size = roof opening size Daylight size = roof opening size - 20 cm  | 60/60 | 313.00 | 222.00 | 153.00 | 214.00 | 263.00 | 466.00 | 527.00 | 576.00 |
| | 60/90 | 350.00 | 236.00 | 214.00 | 299.00 | - | 564.00 | 649.00 | - |
| | 80/80 | 371.00 | 241.00 | 255.00 | 347.00 | 425.00 | 626.00 | 718.00 | 796.00 |
| | 90/90 | 428.00 | 249.00 | 294.00 | 402.00 | 514.00 | 722.00 | 830.00 | 942.00 |
| | 90/120 | 472.00 | 263.00 | 377.00 | 515.00 | 640.00 | 849.00 | 987.00 | 1,112.00 |
| | 100/100 | 466.00 | 259.00 | 339.00 | 464.00 | 570.00 | 805.00 | 930.00 | 1,036.00 |
| | 100/150 | 555.00 | 281.00 | 495.00 | 682.00 | 905.00 | 1,050.00 | 1,237.00 | 1,460.00 |
| | 120/120 | 517.00 | 277.00 | 438.00 | 607.00 | 774.00 | 955.00 | 1,124.00 | 1,291.00 |
| | 150/150 | 641.00 | 304.00 | 699.00 | 965.00 | 1,189.00 | 1,340.00 | 1,606.00 | 1,830.00 |
| Kerb 3020 Height 30 cm, U value: 1.0 [W/m²K] Nominal size = roof opening size Daylight size = roof opening size - 20 cm  | 60/60 | 517.00 | 222.00 | 153.00 | 214.00 | 263.00 | 670.00 | 731.00 | 780.00 |
| | 60/90 | 589.00 | 236.00 | 214.00 | 299.00 | - | 803.00 | 888.00 | - |
| | 80/80 | 609.00 | 241.00 | 255.00 | 347.00 | 425.00 | 864.00 | 956.00 | 1,034.00 |
| | 90/90 | 653.00 | 249.00 | 294.00 | 402.00 | 514.00 | 947.00 | 1,055.00 | 1,167.00 |
| | 90/120 | 720.00 | 263.00 | 377.00 | 515.00 | 640.00 | 1,097.00 | 1,235.00 | 1,360.00 |
| | 100/100 | 695.00 | 259.00 | 339.00 | 464.00 | 570.00 | 1,034.00 | 1,159.00 | 1,265.00 |
| | 100/150 | 807.00 | 281.00 | 495.00 | 682.00 | 905.00 | 1,302.00 | 1,489.00 | 1,712.00 |
| | 120/120 | 781.00 | 277.00 | 438.00 | 607.00 | 774.00 | 1,219.00 | 1,388.00 | 1,555.00 |
| | 150/150 | 914.00 | 304.00 | 699.00 | 965.00 | 1,189.00 | 1,613.00 | 1,879.00 | 2,103.00 |
| Kerb 1600 Height 16 cm, U value: 1.0 [W/m²K] Nominal size = roof opening size Daylight size = roof opening size  | 60/60 | 327.00 | 222.00 | 255.00 | 347.00 | 425.00 | 582.00 | 674.00 | 752.00 |
| | 60/90 | 386.00 | 236.00 | 334.00 | 461.00 | 622.00 | 720.00 | 847.00 | 1,008.00 |
| | 80/80 | 409.00 | 241.00 | 339.00 | 464.00 | 570.00 | 748.00 | 873.00 | 979.00 |
| | 90/90 | 433.00 | 249.00 | 420.00 | 574.00 | 709.00 | 853.00 | 1,007.00 | 1,142.00 |
| | 90/120 | 486.00 | 263.00 | 510.00 | 706.00 | 920.00 | 996.00 | 1,192.00 | 1,406.00 |
| | 100/100 | 455.00 | 259.00 | 438.00 | 607.00 | 774.00 | 893.00 | 1,062.00 | 1,229.00 |
| | 100/150 | 557.00 | 281.00 | 643.00 | 885.00 | 1,228.00 | 1,200.00 | 1,442.00 | 1,785.00 |
| | 120/120 | 524.00 | 277.00 | 622.00 | 859.00 | 1,102.00 | 1,146.00 | 1,383.00 | 1,626.00 |
| | 150/150 | 647.00 | 304.00 | 1,153.00 | 1,632.00 | - | 1,800.00 | 2,279.00 | - |

- = not available ¹ further sizes on request ² further kerbs (e.g. round) on request ³ further types (e.g. 4 shells, pyramidal) on request
⁴ also available in transparent; Further types with PC outer shell or PC Heatstop on request ⁵ with "curved" PC multiwall sheet

alwitra Rooflights accessories

| Opening system ⁶ incl. vent frame | | | Roof hatch or roof hatch with opening system ⁶ incl. vent frame | | | | Vent frame (lockable) ⁷ | |
|---|---------------------------|------------------|---|---|---|---|--|--|
| | | | | | | | | |
| Spindle opener | Electric opening 230 V | NRA type 24 | Manual roof hatch with lockable incl. vent frame | Spindle opener with manual roof hatch incl. vent frame | Electric opening 230 V with manual roof hatch incl. vent frame | NRA Typ 24 with manual roof hatch incl. vent frame | Vent frame with hinges without opening system | |
| incl. vent frame | incl. vent frame | incl. vent frame | incl. vent frame | incl. vent frame | incl. vent frame | incl. vent frame | | |
| €/piece | €/piece | €/piece | €/piece | €/piece | €/piece | €/piece | €/piece | |

| 4a | | | 4b | | | | 4c | |
|--------|----------|----------|----------|----------|----------|----------|--------|---|
| 395.00 | 795.00 | 826.00 | - | - | - | - | 228.00 | S |
| 408.00 | 808.00 | 839.00 | - | - | - | - | 241.00 | S |
| 420.00 | 820.00 | 851.00 | 727.00 | 707.00 | 1,107.00 | 1,138.00 | 253.00 | S |
| 427.00 | 827.00 | 858.00 | 734.00 | 714.00 | 1,114.00 | 1,145.00 | 260.00 | S |
| 443.00 | 843.00 | 874.00 | 830.00 | 770.00 | 1,170.00 | 1,201.00 | 276.00 | S |
| 437.00 | 837.00 | 868.00 | 744.00 | 724.00 | 1,124.00 | 1,155.00 | 270.00 | S |
| 476.00 | 1,291.00 | 957.00 | 863.00 | 803.00 | 1,618.00 | 1,284.00 | 309.00 | S |
| 452.00 | 1,267.00 | 933.00 | 839.00 | 779.00 | 1,594.00 | 1,260.00 | 285.00 | S |
| 513.00 | 1,328.00 | 994.00 | 900.00 | 840.00 | 1,655.00 | 1,321.00 | 346.00 | S |
| 395.00 | 795.00 | 826.00 | - | - | - | - | 228.00 | S |
| 408.00 | 808.00 | 839.00 | - | - | - | - | 241.00 | S |
| 420.00 | 820.00 | 851.00 | 727.00 | 707.00 | 1,107.00 | 1,138.00 | 253.00 | S |
| 427.00 | 827.00 | 858.00 | 734.00 | 714.00 | 1,114.00 | 1,145.00 | 260.00 | S |
| 443.00 | 843.00 | 874.00 | 830.00 | 770.00 | 1,170.00 | 1,201.00 | 276.00 | S |
| 437.00 | 837.00 | 868.00 | 744.00 | 724.00 | 1,124.00 | 1,155.00 | 270.00 | S |
| 476.00 | 1,291.00 | 957.00 | 863.00 | 803.00 | 1,618.00 | 1,284.00 | 309.00 | S |
| 452.00 | 1,267.00 | 933.00 | 839.00 | 779.00 | 1,594.00 | 1,260.00 | 285.00 | S |
| 513.00 | 1,328.00 | 994.00 | 900.00 | 840.00 | 1,655.00 | 1,321.00 | 346.00 | S |
| 420.00 | 820.00 | 851.00 | 727.00 | 707.00 | 1,107.00 | 1,138.00 | 253.00 | S |
| 430.00 | 830.00 | 861.00 | 737.00 | 717.00 | 1,117.00 | 1,148.00 | 263.00 | S |
| 437.00 | 837.00 | 868.00 | 744.00 | 724.00 | 1,124.00 | 1,155.00 | 270.00 | S |
| 449.00 | 849.00 | 880.00 | 756.00 | 736.00 | 1,136.00 | 1,167.00 | 282.00 | S |
| 468.00 | 1,283.00 | 1,164.00 | 855.00 | 795.00 | 1,610.00 | 1,491.00 | 301.00 | S |
| 452.00 | 1,267.00 | 1,148.00 | 839.00 | 779.00 | 1,594.00 | 1,475.00 | 285.00 | S |
| 824.00 | 2,289.00 | 2,124.00 | 1,036.00 | 1,151.00 | 2,616.00 | 2,451.00 | 350.00 | T |
| 476.00 | 1,291.00 | 1,172.00 | 863.00 | 803.00 | 1,618.00 | 1,499.00 | 309.00 | S |
| 861.00 | 2,326.00 | 2,161.00 | - | - | - | - | 387.00 | T |

- = not available S = type Solo T = type Tandem

⁶ for daily ventilation, incl. all hardware / consoles ⁷ A spindle opener, motor opener or roof hatch is additionally required.

Fall-through protection grating

alwitra fall-through protection grating for alwitra Rooflights and Kerbs

Certified according GS-BAU 18

| Product | Ordering size * | €/piece |
|---|---------------------|---------------|
| | Width x Length [cm] | |
| <p>alwitra fall-through protection grating</p> <p>galvanised and coloured in white (~ RAL 9016)</p>  | 40 x 40 | 424.00 |
| | 40 x 70 | 490.00 |
| | 60 x 60 | 532.00 |
| | 60 x 90 | 592.00 |
| | 70 x 70 | 583.00 |
| | 70 x 100 | 609.00 |
| | 80 x 80 | 609.00 |
| | 80 x 130 | 655.00 |
| | 90 x 90 | 622.00 |
| | 90 x 120 | 676.00 |
| | 100 x 100 | 676.00 |
| | 100 x 150 | 721.00 |
| | 120 x 120 | 700.00 |
| | 130 x 130 | 721.00 |
| 150 x 150 | 831.00 | |



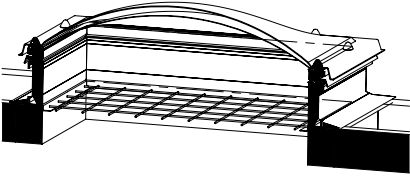
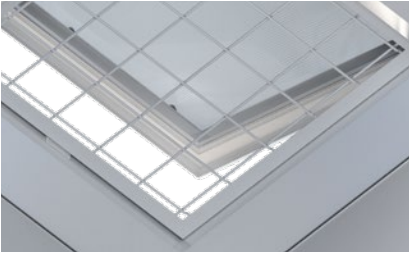
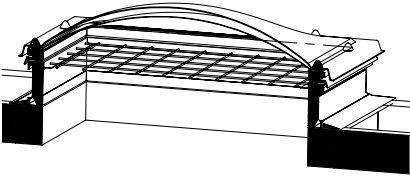
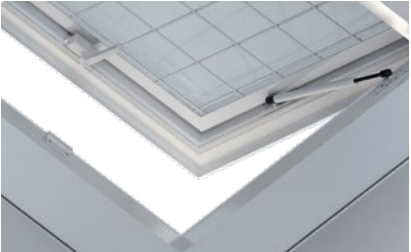
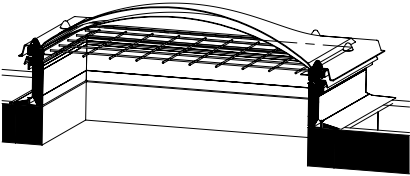

* further sizes on request

Installation methods alwitra fall-through protection grating

| | dimensions | Installation methods |
|---|--|--|
|  |  | <p>1. In the roof opening</p> <p>(on the substructure under the kerb)</p> <p>order size = roof opening size (nominal size)</p> |
|  |  | <p>2. In the kerb</p> <p>(from the topside in the kerb opening, directly underneath the rooflight respectively the vent frame)</p> <p>order size = daylight size</p> |
|  |  | <p>3. In the vent frame</p> <p>(from the topside in the vent frame, directly underneath the rooflight)</p> <p>order size = daylight size Roof access hatch possibly. Not combinable with all drives/ opening systems. Possible on demand.</p> |

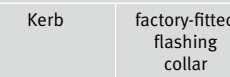
alwitra-DayLuxe window 2.0

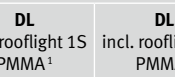
alwitra Kerbs and DayLuxe window 2.0

| Product | Nominal size | light area m ² | Kerb ² | | DayLuxe window 2.0 (DL) | | Complete (Kerb + DL) | |
|---------|--------------|---------------------------|---|---|---|---|---|--|
| | | | Kerb | factory-fitted flashing collar EVALON [®] /EVALASTIC [®] | DL incl. rooflight 1S PMMA ¹ rigid | DL incl. rooflight 1S PMMA ¹ ventilated ² | Complete Kerb+DL window+1S PMMA rigid | Complete Kerb+DL window+1S PMMA ventilated |
| | | | €/piece | €/piece | €/piece | €/piece | €/piece | €/piece |
| | | |  |  |  |  |  | |

| Kerb 1620 | Nominal size | light area m ² | ① | ② | ③ | ③a | S | ① + ③ | ① + ③a |
|---|--------------|---------------------------|--|--------|----------|----------|---|----------|----------|
| | | | Height 16 cm, U value: 0.92 [W/m ² K] | 60/90 | 0.28 | 350.00 | | 236.00 | 981.00 |
| Nominal size = roof opening size Daylight size = roof opening size - 20 cm | 80/80 | 0.36 | 371.00 | 241.00 | 1,088.00 | - | | 1,459.00 | - |
| | 90/90 | 0.49 | 428.00 | 249.00 | 1,141.00 | 2,080.00 | S | 1,569.00 | 2,508.00 |
| | 90/120 | 0.7 | 472.00 | 263.00 | 1,351.00 | 2,290.00 | S | 1,823.00 | 2,762.00 |
| | 100/100 | 0.64 | 466.00 | 259.00 | 1,263.00 | 2,202.00 | S | 1,729.00 | 2,668.00 |
| | 100/150 | 1.04 | 555.00 | 281.00 | 1,645.00 | 2,584.00 | S | 2,200.00 | 3,139.00 |
| | 120/120 | 1 | 517.00 | 277.00 | 1,533.00 | 2,472.00 | S | 2,050.00 | 2,989.00 |
| | 150/150 | 1.69 | 641.00 | 304.00 | 2,114.00 | - | | 2,755.00 | - |

| Kerb 3020 | Nominal size | light area m ² | ① | ② | ③ | ③a | S | ① + ③ | ① + ③a |
|---|--------------|---------------------------|---|--------|----------|----------|---|----------|----------|
| | | | Height 30 cm, U value: 1.0 [W/m ² K] | 60/90 | 0.28 | 589.00 | | 236.00 | 981.00 |
| Nominal size = roof opening size Daylight size = roof opening size - 20 cm | 80/80 | 0.36 | 609.00 | 241.00 | 1,088.00 | - | | 1,697.00 | - |
| | 90/90 | 0.49 | 653.00 | 249.00 | 1,141.00 | 2,080.00 | S | 1,794.00 | 2,733.00 |
| | 90/120 | 0.7 | 720.00 | 263.00 | 1,351.00 | 2,290.00 | S | 2,071.00 | 3,010.00 |
| | 100/100 | 0.64 | 695.00 | 259.00 | 1,263.00 | 2,202.00 | S | 1,958.00 | 2,897.00 |
| | 100/150 | 1.04 | 807.00 | 281.00 | 1,645.00 | 2,584.00 | S | 2,452.00 | 3,391.00 |
| | 120/120 | 1 | 781.00 | 277.00 | 1,533.00 | 2,472.00 | S | 2,314.00 | 3,253.00 |
| | 150/150 | 1.69 | 914.00 | 304.00 | 2,114.00 | - | | 3,028.00 | - |



| Kerb 1600 | Nominal size | light area m ² | ① | ② | ③ | ③a | S | ① + ③ | ① + ③a |
|---|--------------|---------------------------|---|--------|----------|----------|---|----------|----------|
| | | | Height 16 cm, U value: 1.0 [W/m ² K] | 60/60 | 0.36 | 327.00 | | 222.00 | 1,088.00 |
| Nominal size = roof opening size Daylight size = roof opening size | 60/90 | 0.54 | 386.00 | 236.00 | 1,112.00 | 2,051.00 | S | 1,498.00 | 2,437.00 |
| | 70/70 | 0.49 | 379.00 | 231.00 | 1,141.00 | 2,080.00 | S | 1,520.00 | 2,459.00 |
| | 80/80 | 0.64 | 409.00 | 241.00 | 1,263.00 | 2,202.00 | S | 1,672.00 | 2,611.00 |
| | 90/90 | 0.81 | 433.00 | 249.00 | 1,419.00 | 2,358.00 | S | 1,852.00 | 2,791.00 |
| | 90/120 | 1.08 | 486.00 | 263.00 | 1,662.00 | 2,601.00 | S | 2,148.00 | 3,087.00 |
| | 100/100 | 1 | 455.00 | 259.00 | 1,533.00 | 2,472.00 | S | 1,988.00 | 2,927.00 |
| | 100/150 | 1.5 | 557.00 | 281.00 | 2,017.00 | 3,649.00 | T | 2,574.00 | 4,206.00 |
| | 100/200 | 2 | 647.00 | 304.00 | 2,421.00 | 4,053.00 | T | 3,068.00 | 4,700.00 |
| | 120/120 | 1.44 | 524.00 | 277.00 | 1,930.00 | 2,869.00 | S | 2,454.00 | 3,393.00 |
| | 150/150 | 2.25 | 647.00 | 304.00 | 2,724.00 | 4,356.00 | T | 3,371.00 | 5,003.00 |

- = not available ¹ transparent or opal; PC-Heatstop on request ² 230 V chain drive "Aumüller KSA", integrated in the frame; temperature -5 °C... +60 °C, rel. humidity < 90 % to 20 °C; < 50 % to 40 °C; non-condensing S = type Solo T = type Tandem

| Accessories daylight systems | | | | Prices without rooflights and kerbs | |
|---|--|---|-----------|-------------------------------------|--|
| | Product | Product specification | | €/piece | |
|  | Switch | for motor opener 230 V, with reversing lock | concealed | 91.00 | |
| | | | surfaced | 131.00 | |
|  | Key switch button | with profile half cylinder Function: open/closed/stop | concealed | 224.00 | |
| | | | surfaced | 264.00 | |
|  | Crank handle | made of aluminium Length: 1.50 m | | 62.00 | |
| | Crank handle, telescopic | 1.75 - 3.00 m adjustable | | 109.00 | |
|  | Spindle opener¹ Solo | 1 spindle opener, Lift infinitely adjustable up to 300 mm | | 167.00 | |
|  | Spindle opener¹ Tandem | 2 spindle opener with coupling bar, Lift infinitely adjustable up to 300 mm | | 474.00 | |
|  | Motor opener¹ 230 V Solo 230 V solo ACK 42 | up to daylight size 900 x 900 mm Chain feed motor 230 V, 0.32 A Lift adjustable from 100 - 400 mm | | 567.00 | |
|  | Motor opener¹ 230 V Solo 230 V solo KSA 250 | daylight size 1,000 x 1,000 up to 1,300 x 1,300 Chain feed motor 230 V; 0.2 A Lift 250 mm | | 982.00 | |
|  | Motor opener¹ 230 V Tandem 230 V tandem KSA 250 | daylight size 1,500 x 1,500 mm 2 chain feed motors 230 V; 2 x 0.2 A Lift 250 mm | | 1,939.00 | |

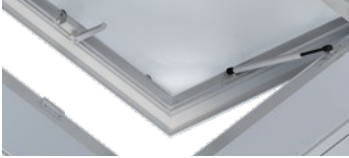
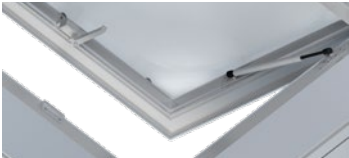
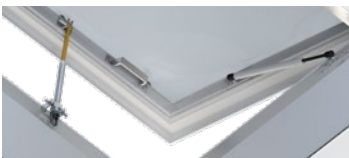
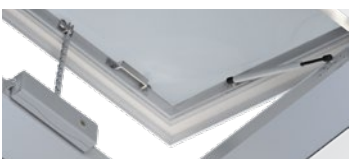
¹ The installation is only possible with a vent frame.

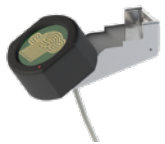
| Accessories roof hatches | | Prices without rooflights and kerbs | |
|--|---|--|---------------|
| | Product | Product specification | €/piece |
|  | Roof hatch¹ manual with lockable opener | for alwitra rooflights max. daylight size 900 x 900 mm | 474.00 |
|  | Roof hatch¹ manual with lockable opener | for alwitra rooflights daylight size 1,000 x 1,000 up to 1,300 x 1,300 | 554.00 |
|  | Roof hatch¹ manual in combination with a spindle drive or motor drive | for alwitra rooflights max. daylight size 900 x 900 mm | 287.00 |
|  | Roof hatch¹ manual in combination with a spindle drive or motor drive | for alwitra rooflights daylight size 1,000 x 1,000 up to 1,300 x 1,300 | 327.00 |



| Accessories wind guard and rain guard systems | | Prices without rooflights and kerbs | |
|---|--------------------------------------|--|---------------|
| | Product | Product specification | €/piece |
|  | Rain guard Type 230 | For supervising of motor opener 230 V, incl. integrated evaluation circuit and installation console | 412.00 |
|  | Wind guard and rain guard WRS | incl. external evaluation unit for motor opener 230 V consisting of: wind and rain sensor, external evaluation unit, mast bracket / wall bracket Protrusion: approx. 510 mm, height: approx. 500 mm | 982.00 |
|  | Stand bracket | For the installation of the rain guard type 230 or for the conversion of the wind and rain guard WRS Standing surface: Diameter: 1,330 mm Height: 1,775 mm | 419.00 |

¹ The installation is only possible with a vent frame. Not suitable for DayLuxe window 2.0. The use of roof exits may not be technically possible (e.g. due to installed fall-through grids). Please request.

Natural smoke vent type 24

Accessories

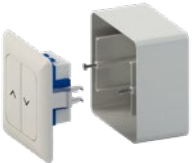
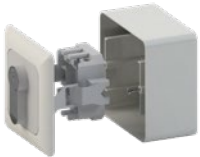



(Prices for rooflights and kerbs see page 64/65)

| | Product | Product specification | €/piece |
|--|--|---|----------------------------|
|  <p>Illustration: Control unit 5 A surfaced</p> | NRA Type 24 | In surface sheet steel housing, with emergency-power supply 24 V DC For the usage of maximum 10 release buttons and 10 smoke sensors. | |
| | Control unit 5 A for surfaced installation | 5 A incl. 2 accumulators 12 V, each with 2.3 Ah, 1 ventilation line input Dimensions (W x H x D): 225 x 285 x 122 mm | 1,091.00 |
| | Control unit 5 A for concealed installation | 5 A incl. 2 accumulators 12 V, each with 2.3 Ah, 1 ventilation line input Dimensions (W x H x D): 254 x 314 x 96/122 mm | 1,259.00 |
| | Control unit 10 A for surfaced installation | 10 A incl. 2 accumulators 12 V, each with 7 Ah, 1 ventilation line input Dimensions (W x H x D): 400 x 300 x 150 mm | 1,432.00 |
| | Control unit 2 x 10 A for concealed installation | 2 x 10 A incl. 2 accumulators 12 V, each with 7 Ah, 2 ventilation lines input Dimensions (W x H x D): 400 x 400 x 200 mm | 1,963.00 |
| There is a minimum of 2 release buttons NRA type 24 necessary for operating. | | | |
|  | Release button for NRA control unit type 24 | Surface housing with release display and control display Colours: grey, red, yellow, orange, blue | 154.00 |
|  | Ventilation switch for NRA control unit type 24 | without reversing lock, Function: open/closed/stop | concealed 90.00 |
| | | | surfaced 130.00 |
|  | Key button for NRA control unit type 24 | with profile half cylinder, Function: open/closed/stop | concealed 224.00 |
| | | | surfaced 264.00 |
|  | Smoke sensor for NRA control unit type 24 | with socket and release display | 217.00 |
|  | Wind guard / rain guard for NRA control unit type 24 | consisting of: Wind and rain sensor 24 V, bracket for mast or wall installation, clamp ring Protrusion: approx. 510 mm; height: approx. 500 mm | 428.00 |

Natural smoke vent type 24

Opening device NRA motor opener type 24

(Prices for rooflights and kerbs see page 64/65)

| | Product | Product specification | €/piece |
|---|--|--|-----------------|
| The motor openers are factory-fitted installed in the rooflights. The installation is only possible with a vent frame | | | |
| For kerbs 1620 and 3020 | | | |
|  | NRA motor opener Solo 24 V solo ACK 44 | (up to daylight size 900 x 900 mm resp. < 1.00 m ²) Chain feed motor, Lift: max. 400 mm; 24 V DC; 1.35 A | 598.00 |
|  | NRA motor opener Solo 24 V solo LKS 500 | (from daylight size 1,000 x 1,000 mm resp. 700 x 1,000 m) Rack and pinion drive, Lift: 500 mm; 24 V DC; 0.8 A | 648.00 |
| For kerb 1600 | | | |
|  | NRA motor opener Solo 24 V solo ACK 44 | (up to daylight size 900 x 900 mm resp. < 1.00 m ²) Chain feed motor, Lift: max. 400 mm; 24 V DC; 1.35 A | 598.00 |
|  | NRA motor opener Solo 24 V solo KSA 500 | (daylight size 1,000 x 1,000 mm and 1,200 x 1,200 mm) Chain feed motor, Lift: 500 mm; 24 V DC; 1.2 A | 863.00 |
|  | NRA motor opener Tandem "Type Duo" 24 V tandem KSA 500 DUO | (daylight size 1,500 x 1,500 mm and 1,000 x 1,500 mm) 1 drive with 2 chains, Lift: 500 mm; 24 V DC; 2.4 A | 1,774.00 |
|  | NRA motor opener Tandem 24 V tandem KSA 500 | (daylight size ≥ 2,000 x ≥ 600 mm) 2 drives with 2 chains, Lift: 500 mm; 24 V DC; 2 x 1.2 A | 1,726.00 |





EVASTEEL



EVASTEEL



1 **Base element for rainwater outlets or vent stacks 110** incl.
 - Connecting flange bitumen: for flashing against vapour barriers or
 - Flange stainless steel: for flashing against various vapour barriers

+ **2a** **Extension element 110**
 incl. connecting flange 110,
 for bridging the thermal insulation

+ **3a** **Leaf guard grating universal**
 or

3b **Emergency outlet set 110** consisting of:
 leaf guard grating - emergency outlet
 and accumulation ring 110

+ **2b** **Vent stack top element 110**
 incl. connecting flange 160,
 for bridging the thermal insulation

+ **3c** **Vent cowl 110**
 (optional)

Price fixing of EVASTEEL rainwater outlets and vent stacks

Explanation of the price fixing for alwitra EVASTEEL rainwater outlets (see pages 76-76)

| No. | Product | €/piece |
|-----------------------|--|---------|
| 1 | Base element for rainwater outlets or vent stacks 110 incl. - Connecting flange bitumen: for flashing against vapour barriers or - Flange stainless steel: for flashing against various vapour barriers | _____ € |
| 2a | Extension element 110 incl. connecting flange 110, for bridging the thermal insulation | _____ € |
| 3a | Leaf guard grating universal or or | _____ € |
| 3b | Emergency outlet set 110 consisting of: leaf guard grating - emergency outlet and accumulation ring 110 | _____ € |
| = Total amount | | _____ € |

Explanation of the price fixing for alwitra EVASTEEL vent stack (page 80/81)

| No. | Product | €/piece |
|-----------------------|--|---------|
| 1 | Base element for rainwater outlets or vent stacks 110 incl. - Connecting flange bitumen: for flashing against vapour barriers or - Flange stainless steel: for flashing against various vapour barriers | _____ € |
| 2b | Vent stack top element 110 incl. connecting flange 160, for bridging the thermal insulation | _____ € |
| 3c | Vent cowl 110 (optional) | _____ € |
| = Total amount | | _____ € |





Rainwater outlets

EVASTEEL rainwater outlet, vertical

| | Product | Dimension | €/piece |
|---|---|-----------|---------------|
|  | <p>EVASTEEL base element for rainwater outlet/vent stack 110 - bitumen</p> <p>made of stainless steel V4A, DN100 (OD110), with connecting flange bitumen, for flashing against bitumen vapour barriers, incl. lip seal for adding an extension element 110 or vent stacks 110</p> <p>height: 280 mm, required Ø of the ceiling opening: approx. 125 mm</p> | DN 100 | 101.00 |
|  | <p>EVASTEEL base element for rainwater outlet/vent stack 110 - flange</p> <p>made of stainless steel V4A, DN100 (OD110), for flashing against various vapour barriers, incl. lip seal for adding an extension element 110 or vent stack 110</p> <p>height: 280 mm, flange: approx. 330 x 330 mm, required Ø of the ceiling opening: approx. 125 mm</p> | DN 100 | 95.00 |
|  | <p>EVASTEEL extension element 110 short</p> <p>made of stainless steel V4A, DN 100 (OD 110 mm), for bypassing the thermal insulation, with EVALON® or EVALASTIC® coated flange made of special V4A stainless steel metal sheet for direct welding of EVALON® or EVALASTIC® connecting flanges (connecting flange is included in the delivery scope), suitable for EVASTEEL base element 110</p> <p>height: 250 mm, for thermal insulation thicknesses until max. 170 mm</p> <p>Note: leaf guard grating universal or emergency outlet 110 are not included and must be ordered separately!</p> <p>for waterproofing made of</p> | DN 100 | |
| | <p>EVALON® (white, light grey, slate grey, other colours on request)</p> | | 95.00 |
| | <p>EVALASTIC® (light grey, slate grey matt)</p> | | 95.00 |
|  | <p>EVASTEEL extension element 110 long</p> <p>made of stainless steel V4A, DN 100 (OD 110 mm), for bypassing the thermal insulation, with EVALON® or EVALASTIC® coated flange made of special V4A stainless steel metal sheet for direct welding of EVALON® or EVALASTIC® connecting flanges (connecting flange is included in the delivery scope), suitable for EVASTEEL base element 110</p> <p>height: 600 mm, for thermal insulation thicknesses until max. 520 mm</p> <p>Note: leaf guard grating universal or emergency outlet 110 are not included and must be ordered separately!</p> <p>for waterproofing made of</p> | DN 100 | |
| | <p>EVALON® (white, light grey, slate grey, other colours on request)</p> | | 123.50 |
| | <p>EVALASTIC® (light grey, slate grey matt)</p> | | 123.50 |

Accessories and spare parts rainwater outlets

EVASTEEL accessories and spare parts rainwater outlets vertical

| | Product | Dimension | €/piece |
|---|--|-------------------|---------------|
| <p>3a</p>  | <p>EVASTEEL leaf guard universal</p> <p>made of stainless steel V4A, DN 50 (OD50) until DN 150 (OD160)</p> | DN 50 - DN 150 | 68.50 |
| <p>3b</p>  | <p>EVASTEEL emergency outlet set 110 for easy extension of EVASTEEL rainwater outlets 110</p> <p>emergency outlet set consisting of: leaf guard grating emergency outlet made of stainless steel V4A and accumulation ring 110 made of EPDM, ponding height 25 - 55 mm, adjustable by cutting</p> | DN 100 | 148.50 |
|  | <p>Connecting flange 110 *</p> <p>fitting for all EVASTEEL extension elements 110,</p> <p>dimensions: 480 x 480 mm, thickness: 1.5 mm</p> <p>* can be ordered separately, generally included in the delivery scope with extension elements, vent stack top elements and penetrations</p> <p>for waterproofing made of</p> | | |
| | EVALON® (white, light grey, slate grey, other colours on request) | | 13.00 |
| | EVALASTIC® (light grey, slate grey matt) | | 13.00 |
|  | <p>EVASTEEL accumulation ring 110</p> <p>made of EPDM, for DN 100 (OD 110), ponding height 25 - 75 mm, adjustable by cutting</p> | DN 100 | 44.00 |



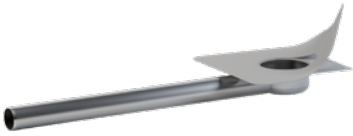

Rainwater outlets

EVASTEEL rainwater outlet, horizontal

| | Product | Dimension | €/piece |
|---|--|-----------|---------------|
|  | <p>EVASTEEL rainwater outlet horizontal 75</p> <p>made of stainless steel V4A, DN 70 (OD75 mm) with EVALON® or EVALASTIC® coated flange made of special V4A stainless steel metal sheet for direct welding of EVALON® or EVALASTIC® connecting flanges (connecting flange is included in the delivery scope),</p> <p>pipe length: 1.000 mm, installation height: 90 mm Ø of the top opening: 160 mm requirement Ø of the ceiling opening: approx. 170 mm</p> <p>Note: Leaf guard grating universal or emergency outlet 160 are not included and must be ordered separately!</p> <p>for waterproofing made of</p> | DN 70 | |
| | EVALON® (white, light grey, slate grey, other colours on request) | | 380.50 |
| | EVALASTIC® (light grey, slate grey matt) | | 380.50 |



Accessories and spare parts rainwater outlets

EVASTEEL Accessories and spare parts rainwater outlets, horizontal

| | Product | Dimension | €/piece |
|--|--|-------------------|---------------|
|  <p>3a</p> | <p>EVASTEEL leaf guard universal</p> <p>made of stainless steel V4A, DN 50 (OD50) until DN 150 (OD160)</p> | DN 50 - DN 150 | 68.50 |
|  | <p>EVASTEEL emergency outlet set 160</p> <p>for easy extension of EVASTEEL rainwater outlets horizontal 75</p> <p>emergency outlet set consisting of: leaf guard grating emergency outlet made of stainless steel V4A and accumulation ring 160 made of EPDM, ponding height 25 - 55 mm, adjustable by cutting</p> | DN 150 | 168.50 |
|  | <p>Connecting flange 160 *</p> <p>fitting for all EVASTEEL rainwater outlets horizontal 75, vent stack top elements 110, vent stack top element 110 to 90, penetrations 110</p> <p>dimensions: 480 x 480 mm, thickness: 1.5 mm</p> <p>* can be ordered separately, generally included in the delivery scope of rainwater outlets horizontal 75</p> <p>for waterproofing made of</p> | | |
| | EVALON® (white, light grey, slate grey, other colours on request) | | 13.00 |
| | EVALASTIC® (light grey, slate grey matt) | | 13.00 |
|  | <p>EVASTEEL accumulation ring 160</p> <p>made of EPDM, for DN 150 (OD 160), ponding height 25 - 75 mm, adjustable by cutting</p> | DN 150 | 64.00 |
|  | <p>base plate/refurbishment plate 75</p> <p>as penetration and flashing of the EVASTEEL rainwater outlet horizontal 75 to a vapour barrier</p> <p>outer Ø: DN 70 (OD 75), incl. lip seal ring inner Ø: approx. 320 mm</p> | DN 70 | 54.50 |

Vent stack and accessories

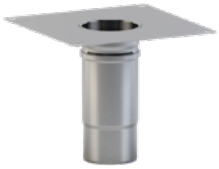
EVASTEEL vent stack and accessories

| | Product | Dimension | €/piece |
|---|--|-----------|---------------|
|  | <p>EVASTEEL base element for rainwater outlet/vent stack 110 - bitumen</p> <p>made of stainless steel V4A, DN100 (OD110), with connecting flange bitumen, for flashing against bitumen vapour barriers, incl. lip seal for adding an extension element 110 or vent stacks 110</p> <p>height: 280 mm, required Ø of the ceiling opening: approx. 125 mm</p> | DN 100 | 101.00 |
|  | <p>EVASTEEL base element for rainwater outlet/vent stack 110 - flange</p> <p>made of stainless steel V4A, DN100 (OD110), for flashing against various vapour barriers, incl. lip seal for adding an extension element 110 or vent stack 110</p> <p>height: 280 mm, flange: approx. 330 x 330 mm, required Ø of the ceiling opening: approx. 125 mm</p> | DN 100 | 95.00 |
|  | <p>EVASTEEL vent stack top element 110</p> <p>made of stainless steel V4A, DN 100 (OD 110 mm), for bypassing the thermal insulation, with EVALON® or EVALASTIC® coated flange made of special V4A stainless steel metal sheet for direct welding of EVALON® or EVALASTIC® connecting flanges (connecting flange is included in the delivery scope), suitable for EVASTEEL base element 110</p> <p>Pipe length below roof waterproofing: 400 mm for thermal insulation thicknesses until max. 320 mm</p> <p>Note: vent cowl 110 is not included in the delivery scope and may have to be ordered separately!</p> <p>for waterproofing made of</p> | DN 100 | |
| | <p>EVALON® (white, light grey, slate grey, other colours on request)</p> | | 174.00 |
| | <p>EVALASTIC® (light grey, slate grey matt)</p> | | 174.00 |
|  | <p>Backflow sealing</p> <p>flexible multiple lip seal made of EPDM for the backflow-proofed flashing of vertical pipes or drainage elements DN 100 (OD110) towards vertical pipes without a sleeve DN 100 (OD110)</p> <p>for pipes with inner diameter of 120 - max. 135 mm</p> | DN 100 | 29.00 |

Vent stack and accessories

EVASTEEL vent stack and accessories

| | Product | Dimension | €/piece |
|---|--|-----------|---------------|
|  | <p>EVASTEEL vent stack top element 110 to 90</p> <p>made of stainless steel V4A, DN 90 (OD 90 mm), for bypassing the thermal insulation, with EVALON® or EVALASTIC® coated flange made of special V4A stainless steel metal sheet for direct welding of EVALON® or EVALASTIC® connecting flanges (connecting flange is included in the delivery scope), suitable for refurbishment of existing downpipes (inside Ø: approx. 105 - 111 mm) with optionally available backflow sealing</p> <p>pipe diameter below roof waterproofing: 90 mm pipe length below roof waterproofing: 400 mm pipe diameter above roof waterproofing: 110 mm</p> <p>Note: vent cowl 110 is not included in the delivery scope and may have to be ordered separately!</p> <p>for waterproofing made of</p> | DN 90 | |
| | EVALON® (white, light grey, slate grey, other colours on request) | | 184.50 |
| | EVALASTIC® (light grey, slate grey matt) | | 184.50 |
|  | <p>Connecting flange 160 *</p> <p>fitting for all EVASTEEL vent stack top elements 110, vent stack top element 110 to 90, penetrations 110, rainwater outlets horizontal 75</p> <p>dimensions: 480 x 480 mm, thickness: 1.5 mm</p> <p>* can be ordered separately, generally included in the delivery scope of rainwater outlets horizontal 75</p> <p>for waterproofing made of</p> | | |
| | EVALON® (white, light grey, slate grey, other colours on request) | | 13.00 |
| | EVALASTIC® (light grey, slate grey matt) | | 13.00 |
|  | <p>EVASTEEL vent cowl 110</p> <p>of stainless steel V4A, DN 100 (OD110), waterproof against driving rain,</p> <p>for EVASTEEL vent stack top elements 110, vent stack top elements 110 to 90, penetrations 110</p> | DN 100 | 92.50 |
|  | <p>Backflow sealing</p> <p>flexible multiple lip seal made of EPDM for the backflow-proofed flashing of vertical pipes or drainage elements DN 90 (OD90) towards vertical pipes without a sleeve DN 90 (OD90)</p> <p>for pipes with inner diameter of 105 - max. 111 mm</p> | DN 90 | 24.50 |



Penetrations and accessories

EVASTEEL penetrations and accessories

| | Product | Dimension | €/piece |
|---|--|-----------|---------------|
|  | <p>EVASTEEL penetration set 110</p> <p>made of Stainless steel V4A, DN 100 (OD 110 mm), with EVALON® or EVALASTIC® coated flange made of special V4A stainless steel metal sheet for direct welding of EVALON® or EVALASTIC® connecting flanges (connecting flange is included in the delivery scope),</p> <p>incl. stainless steel pipe elbow set consisting of 3 x 45° stainless steel pipe elbows V2A, for waterproofing made of</p> | DN 100 | |
| | EVALON® (white, light grey, slate grey, other colours on request) | | 249.00 |
| | EVALASTIC® (light grey, slate grey matt) | | 249.00 |
|  | <p>Connecting flange 160 *</p> <p>fitting for all EVASTEEL vent stack top elements 110, vent stack top element 110 to 90, penetrations 110, rainwater outlets horizontal 75</p> <p>dimensions: 480 x 480 mm, thickness: 1.5 mm</p> <p>* can be ordered separately, generally included in the delivery scope of rainwater outlets horizontal 75</p> <p>for waterproofing made of</p> | | |
| | EVALON® (white, light grey, slate grey, other colours on request) | | 13.00 |
| | EVALASTIC® (light grey, slate grey matt) | | 13.00 |
|  | <p>EVASTEEL pipe elbow set 110 - 3 x 45° V2A</p> <p>set consisting of 3 x 45° stainless steel pipe elbows V2A, DN 100 (OD110)</p> | DN 100 | 163.50 |

Penetrations and accessories

EVASTEEL penetrations and accessories

| | Product | Dimension | €/piece |
|---|---|-----------|--------------|
|  | <p>EVASTEEL penetration 110</p> <p>made of stainless steel V4A, DN 100 (OD 110 mm), with EVALON® or EVALASTIC® coated flange made of special V4A stainless steel metal sheet for direct welding of EVALON® or EVALASTIC® connecting flanges (connecting flange is included in the delivery scope)</p> <p>Note: pipe open on top. Stainless steel pipe elbows are not included in the delivery scope and may have to be ordered separately!</p> <p>for waterproofing made of</p> | DN 100 | |
| | EVALON® (white, light grey, slate grey, other colours on request) | | 85.50 |
| | EVALASTIC® (light grey, slate grey matt) | | 85.50 |
|  | <p>EVASTEEL pipe elbow set 110 - 45° V2A</p> <p>made of stainless steel V2A, DN 100 (OD 110 mm),</p> <p>Note: this product is just one stainless steel pipe elbow, at least 3 pieces are needed!</p> | DN 100 | 54.50 |
|  | <p>EVASTEEL vent cowl 110</p> <p>made of stainless steel V4A, DN 100 (OD110), waterproof against driving rain,</p> <p>for EVASTEEL vent stack top elements 110, vent stack top elements 110 to 90, penetrations 110</p> | DN 100 | 92.50 |

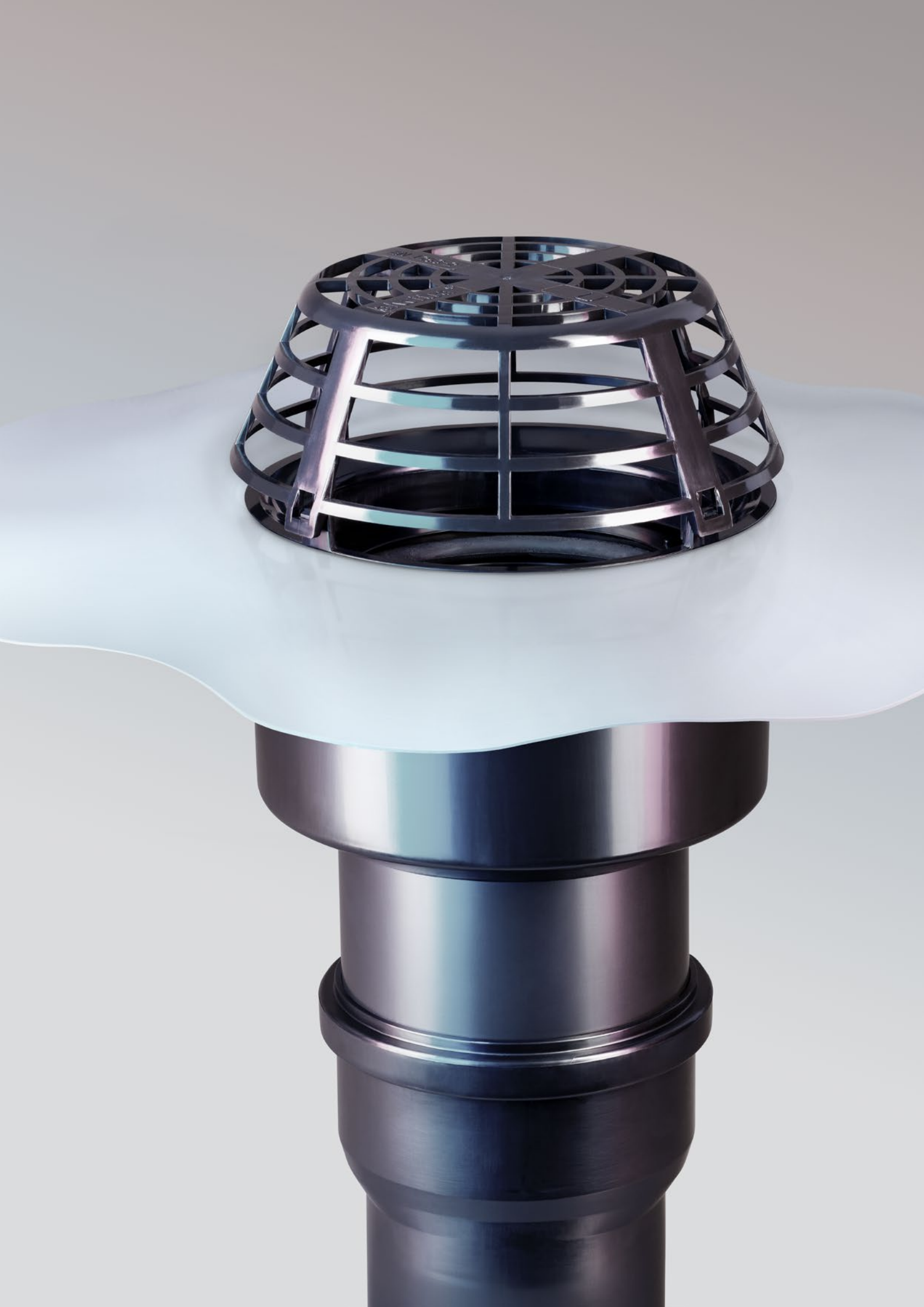

Flat roof drainage

Flat roof drainage

alwitra rainwater outlets





alwitra

Please also note our **new EVASTEEL roof drainage system** (see pages 74-83)

alwitra rainwater outlets

| | Product | Dimension | €/piece |
|---|---|-------------------|---------------|
|  | <p>Rainwater outlet S 125/110 DN 125 (OD 125 mm) and DN 100 (OD 110 mm), vertical outlet</p> <p>Thermally insulated alwitra rainwater outlet vertical, made of polypropylen (PP), DN 125 (OD 125 mm), incl. reducer to DN 100 (OD 110 mm), screw ring, leaf guard and gravel stop</p> <p>required Ø of the ceiling opening: approx. 185 up to 200 mm</p> | DN 125 and DN 100 | 84.00 |
|  | <p>Rainwater outlet SH 125/110, DN 125 (OD 125 mm) and DN 100 (OD 110 mm), vertical outlet, heatable</p> <p>Thermally insulated, heatable rainwater outlet vertical, made of polypropylen (PP), connection to 230 V AC, DN 125 (OD 125 mm), incl. reducer to DN 100 (OD 110 mm), screw ring, leaf guard and gravel stop. Connection only with a thermostat (see accessories page 94)</p> <p>required Ø of the ceiling opening: approx. 185 up to 200 mm</p> | DN 125 and DN 100 | 193.50 |
|  | <p>Adapter 125/160, eccentric</p> <p>for connecting the rainwater outlets S 125/110 and SH 125/110 to downpipes DN 150 (OD 160 mm)</p> | DN 125 to DN 150 | 24.50 |
|  | <p>Reducer 125/75, eccentric</p> <p>for connecting the rainwater outlets S 125/110 and SH 125/110 to downpipes DN 70 (OD 75 mm)</p> | DN 125 to DN 70 | 10.50 |
|  | <p>Parapet outlet W75 for roof or emergency drainage</p> <p>Attic outlet as a set consisting of:</p> <ul style="list-style-type: none"> · Rainwater outlet W75 with factory fitted flashing collar made of EVALON® or EVALASTIC® · Screw ring, emergency outlet socket 40, leaf guard and gravel stop · Base plate DN 70 made of aluminium for flashing against a vapour barrier · Factory fitted insulation corpus made of XPS with straight outer edges for an easy connection to the horizontal surface insulation; dimensions: 675 x 500 x 160 mm · Connection pipe made of stainless steel DN 70 (OD 75 mm): length 1,000 mm; satin silver pipe with sleeve as free outlet or for connecting towards standard DN drainage pipes <p>Also available with heated rainwater outlet (230 V AC). Price on request.</p> | | 415.00 |

alwitra rainwater outlets





| | Product | Dimension | €/piece |
|---|--|------------------|---------------|
|  | <p>Rainwater outlet W 125, DN 125 (OD 125 mm), horizontal outlet</p> <p>Thermally insulated rainwater outlet with horizontal outlet, made of polypropylen (PP), DN 125 (OD 125 mm), incl. screw ring, leaf guard and gravel stop</p> <p>Installation height: 200 mm The necessary ceiling opening is approx. 190 x 280 mm</p> | DN 125 | 108.50 |
|  | <p>Rainwater outlet WH 125, DN 125 (OD 125 mm), horizontal outlet, heatable,</p> <p>Thermally insulated, heatable rainwater outlet with horizontal outlet, made of polypropylen (PP), connection to 230 V AC, DN 125 (OD 125 mm), incl. screw ring, leaf guard and gravel stop, Connection only with a thermostat (see accessories page 94)</p> <p>Installation height: 200 mm The necessary ceiling opening is approx. 190 x 280 mm</p> | DN 125 | 208.00 |
|  | <p>Rainwater outlet W 75/110, DN 70 (OD 75 mm) and DN 100 (OD 110 mm), horizontal outlet</p> <p>Thermally insulated rainwater outlet with horizontal outlet, made of polypropylen (PP), DN 70 (OD 75 mm) and DN 100 (OD 110 mm), incl. adapter to DN 100 (OD 110 mm), screw ring, leaf guard and gravel stop</p> <p>Installation height: 110 mm The necessary ceiling opening is approx. 190 x 250 mm</p> | DN 70 and DN 100 | 108.50 |
|  | <p>Rainwater outlet WH 75/110, DN 70 (OD 75 mm) and DN 100 (OD 110 mm), horizontal outlet, heatable</p> <p>Thermally insulated, heatable rainwater outlet with horizontal outlet, made of polypropylen (PP), connection to 230 V AC, DN 70 (OD 75 mm) and DN 100 (OD 110 mm), incl. adapter to DN 100 (OD 110 mm), screw ring, leaf guard and gravel stop, Connection only with a thermostat (see accessories page 94)</p> <p>Installation height: 110 mm The necessary ceiling opening is approx. 190 x 250 mm</p> | DN 70 and DN 100 | 208.00 |

Flat roof drainage

alwitra rainwater outlets

alwitra

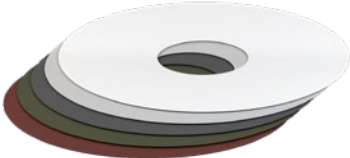
Please also note our **new EVASTEEL roof drainage system** (see pages 74-79)

| alwitra rainwater outlets | | | |
|---|--|--------------|---------------|
| | Product | Dimension | €/piece |
|  | Extension elements Fitting all alwitra rainwater outlets, for bridging thermal insulation layers of warm roofs, made of polypropylen (PP), incl. screw ring and connecting flange made of EVALON® (white, light grey, slate grey, other colours on request) or EVALASTIC® (light grey, slate grey matt), Pipe diameter: approx. 120 mm | | |
| | Extension element 200 for thermal insulation thicknesses from 50 - 200 mm | 50 - 200 mm | 72.50 |
| | Extension element 400 for thermal insulation thicknesses from 50 - 400 mm | 50 - 400 mm | 101.00 |
| | Extension element SL for thermal insulation thicknesses from > 400 mm as individual length according to customer specification | > 400 mm | 130.50 |
|  | Extension element UKD (inverted roof) Fitting all alwitra rainwater outlets, for bridging thermal insulation layers of inverted roofs, made of polypropylen (PP), incl. screw ring for connection to the trickle protection | | |
| | UKD 200 for thermal insulation thicknesses at inverted roofs up to 200 mm | up to 200 mm | 79.50 |
| | UKD 400 for thermal insulation thicknesses at inverted roofs up to 400 mm | up to 400 mm | 108.50 |
|  | Connecting flange Fitting all alwitra rainwater outlets and extension elements, OD 480 mm, thickness 1.5 mm for flashing against the roof waterproofing | OD 480 mm | |
| | EVALON® (white, light grey, slate grey, other colours on request) | | 13.00 |
| | EVALASTIC® (light grey, slate grey matt) | | 13.00 |
|  | Connecting flange bitumen fitting all alwitra rainwater outlets, OD 500 mm, thickness approx. 5 mm for flashing against vapour barriers made of bitumen | OD 500 mm | 22.00 |



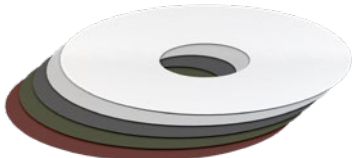

alwitra emergency outlets

| | Product | Dimension | €/piece |
|--|--|-------------|--------------|
|  | Emergency outlet sockets Ponding element for easy conversion of all alwitra rainwater outlets and extension elements (200, 400, SL) into emergency outlets with a specified ponding height | | |
| | Emergency outlet socket 40 ponding height 20 - 40 mm, adjustable by cutting | 20 - 40 mm | 43.50 |
| | Emergency outlet socket 100 ponding height 20 - 100 mm, adjustable by cutting | 20 - 100 mm | 50.50 |
| | Emergency outlet socket SL special length prefabricated ponding height (20 - 95 mm in 5 mm steps) | 20 - 95 mm | 58.00 |
|  | Connecting flange fitting all alwitra rainwater outlets and extension elements, OD 480 mm, thickness 1.5 mm for flashing against the roof waterproofing | OD 480 mm | |
| | EVALON® (white, light grey, slate grey, other colours on request) | | 13.00 |
| | EVALASTIC® (light grey, slate grey matt) | | 13.00 |

| alwitra refurbishment rainwater outlets | | | |
|---|--|-----------|---------------|
| | Product | Dimension | €/piece |
|  | Refurbishment rainwater outlet 125 · for existing rainwater outlets DN 125 (OD 125 mm) and DN 150 (OD 160 mm), · for thermal insulation thicknesses 50 - 200 mm, incl. - refurbishment ring made of PP with rollring and extension element 200, - connecting flange made of EVALON® or EVALASTIC®, - leaf guard and gravel stop for roof waterproofings made of | DN 125 | |
| | EVALON® (white, light grey, slate grey, other colours on request) | | 101.00 |
| | EVALASTIC® (light grey, slate grey matt) | | 101.00 |
|  | Refurbishment rainwater outlet 110 · for existing rainwater outlets DN 100 (OD 110 mm), · for thermal insulation thicknesses 0 - 300 mm, incl. - refurbishment plate made of aluminium DN 100 with lip seal, - refurbishment element DN 100 (OD 110 mm) made of PVC-U with integrated connecting flange made of EVALON® or EVALASTIC® (490 x 490 mm), - wired domed leaf guard for roof waterproofings made of | DN 100 | |
| | EVALON® (white, light grey, slate grey) | | 118.50 |
| | EVALASTIC® (light grey, slate grey matt) | | 161.50 |
|  | Refurbishment rainwater outlet 75 · for existing rainwater outlets DN 70 (OD 75 mm) and DN 90 (OD 90 mm), · for thermal insulation thicknesses 0 - 300 mm, incl. - refurbishment plate made of aluminium DN 70 with lip seal, - refurbishment element DN 70 (OD 75 mm) made of PVC-U with integrated connecting flange made of EVALON® or EVALASTIC® (340 x 340 mm), - wired domed leaf guard for roof waterproofings made of | DN 70 | |
| | EVALON® (white, light grey, slate grey) | | 100.50 |
| | EVALASTIC® (light grey, slate grey matt) | | 138.00 |
|  | Backflow sealing Flexible multiple lip seal made of EPDM for the backflowproofed flashing of pipes or drainage elements DN 50 - DN 125 towards vertical pipes without a sleeve | | |
| | DN 50 (OD 50 mm) for pipes ID min. 61 - max. 77 mm | DN 50 | 20.00 |
| | DN 70 (OD 75 mm) for pipes ID min. 87 - max. 108 mm | DN 70 | 21.00 |
| | DN 90 (OD 90 mm) for pipes ID min. 105 - max. 111 mm | DN 90 | 24.50 |
| | DN 100 (OD 110 mm) for pipes ID min. 120 - max. 135 mm | DN 100 | 29.00 |
| | DN 125 (OD 125 mm) for pipes ID min. 140 - max. 152 mm | DN 125 | 44.50 |

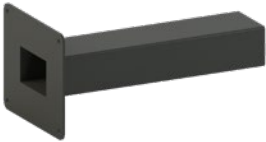

alwitra water spouts (emergency outlets)

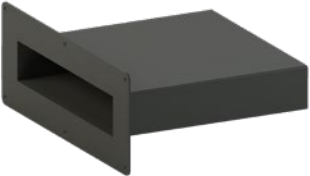
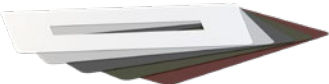
alwitra water spouts EVALON® (emergency outlets)

| | Product | Dimension | €/piece |
|---|---|--------------|---------------|
|  | Water spout type SF rectangular, 80/120 Water spout with rectangular pipe, approx. 80 x 120 mm, as emergency outlet, made of PVC-U with a vertical welding flange Connecting flanges made of EVALON® are directly welded on the flange | 80 x 120 mm | |
| | Pipe length 500 mm | | 155.00 |
| | Pipe length up to 1,000 mm on order | | 190.50 |
|  | Connecting flange for water spout SF rectangular, 80/120 Custom-fit connecting flange made of EVALON® (white, light grey, slate grey, other colours on request) | 430 x 390 mm | 15.50 |
|  | Water spout type SF rectangular, 100/300 Water spout with rectangular pipe, approx. 100 x 300 mm, as emergency outlet, made of PVC-U with a vertical welding flange Connecting flanges made of EVALON® are directly welded on the flange | 100 x 300 mm | |
| | Pipe length 500 mm | | 169.50 |
| | Pipe length up to 1,000 mm on request | | 213.50 |
|  | Connecting flange for water spout SF rectangular, 100/300 Custom-fit connecting flange made of EVALON® (white, light grey, slate grey, other colours on request) | 600 x 450 mm | 15.50 |
|  | Water spout type SF rectangular, 100/500 Water spout with rectangular pipe, approx. 100x500 mm, as emergency outlet, made of PCV-U with a vertical welding flange Connecting flanges made of EVALON® are directly welded on the flange | 100 x 500 mm | |
| | Pipe length 500 mm | | 221.50 |
| | Pipe length up to 1,000 mm on order | | 285.00 |
|  | Connecting flange for water spout SF rectangular, 100/500 Custom-fit connecting flange made of EVALON® (white, light grey, slate grey, other colours on request) | 770 x 450 mm | 15.50 |

alwitra water spouts (emergency outlets)

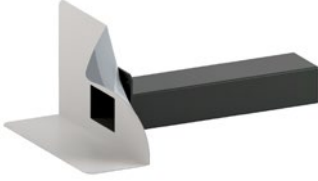
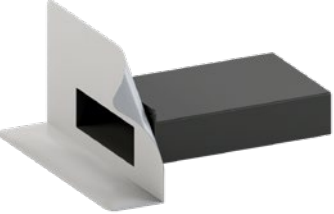
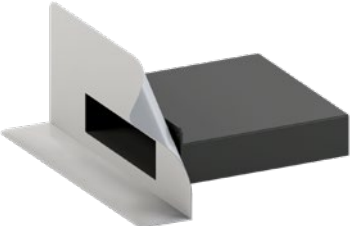
alwitra water spouts EVALON® (emergency outlets)

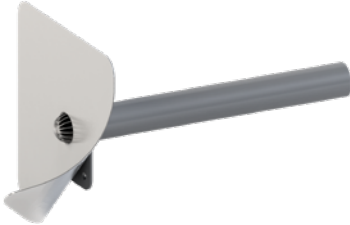

| | Product | Dimension | €/piece |
|---|---|--------------|---------------|
|  | Water spout type SW rectangular, 80/120 Water spout with rectangular pipe approx. 80 x 120 mm, as emergency outlet, made of PVC-U with angled welding flange and factory-fitted EVALON® connecting flange (white, light grey, slate grey, other colours on request), Ponding height 20 - 45 mm (in 5 mm steps) according to customer specification | 80 x 120 mm | |
| | Pipe length 500 mm | | 198.50 |
| | Pipe length up to 1,000 mm on order | | 234.00 |
|  | Water spout type SW rectangular, 100/300 Water spout with rectangular pipe approx. 100 x 300 mm, as emergency outlet, made of PVC-U with angled welding flange and factory-fitted EVALON® connecting flange (white, light grey, slate grey, other colours on request), Ponding height 20 - 45 mm (in 5 mm steps) according to customer specification | 100 x 300 mm | |
| | Pipe length 500 mm | | 216.50 |
| | Pipe length up to 1,000 mm on order | | 261.50 |
|  | Water spout type SW rectangular, 100/500 Water spout with rectangular pipe approx. 100 x 500 mm, as emergency outlet, made of PVC-U with angled welding flange and factory-fitted EVALON® connecting flange (white, light grey, slate grey, other colours on request), Ponding height 20 - 45 mm (in 5 mm steps) according to customer specification | 100 x 500 mm | |
| | Pipe length 500 mm | | 270.50 |
| | Pipe length up to 1,000 mm on order | | 334.00 |
|  | Water spout type S Round emergency outlet made of PVC-U with factory-fitted with EVALON® connecting flange (white, light grey, slate grey, other colours on request), incl. wired domed leaf guard optional base plate for the connection to the vapor barrier see page 94 | | |
| | Pipe length 500 mm | DN 50 | 33.50 |
| | | DN 70 | 38.00 |
| | | DN 100 | 45.00 |
| | Pipe length up to 1,000 mm on order | DN 50 | 49.00 |
| | | DN 70 | 54.50 |
| DN 100 | | 66.00 | |
|  | Water spout type SF Round emergency outlet made of PVC-U with factory-fitted with EVALON® connecting flange (white, light grey, slate grey, other colours on request), incl. wired domed leaf guard Pipe length 500 mm optional base plate for the connection to the vapor barrier see page 94 (not available for DN 90) | DN 50 | 42.00 |
| | | DN 70 | 46.50 |
| | | DN 90 | 55.50 |
| | | DN 100 | 61.50 |
| | | DN 125 | 70.50 |
| | | DN 150 | 86.50 |

alwitra water spouts (emergency outlets)

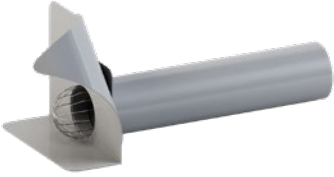
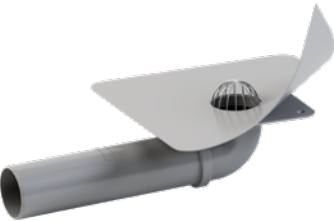



alwitra water spouts EVALON® (emergency outlets)

| | Product | Dimension | €/piece |
|--|---|-----------|--------------|
|  | <p>Water spout type SW</p> <p>Round emergency outlet made of PVC-U with angled flange (production-related accumulation height approx. 5 mm) and factory-fitted EVALON® connecting flange (white, light grey, slate grey, other colours on request),</p> <p>incl. wired domed leaf guard</p> <p>Pipe length 400 mm</p> <p>optional base plate for the connection to the vapor barrier see page 94</p> | DN 50 | 45.50 |
| | | DN 70 | 49.50 |
| | | DN 100 | 65.00 |
|  | <p>Water spout type VF</p> <p>Round emergency outlet made of PVC-U with vertical entry, horizontal flange and factory-fitted EVALON® connecting flange (white, light grey, slate grey, other colours on request),</p> <p>incl. wired domed leaf guard</p> <p>Pipe length 300 mm</p> <p>optional base plate for the connection to the vapor barrier see page 94</p> | DN 50 | 55.50 |
| | | DN 70 | 67.50 |





alwitra water spouts EVALASTIC® (emergency outlets)

| | Product | Dimension | €/piece |
|---|--|-----------|---------------|
|  | <p>Water spout type SF EVALASTIC®</p> <p>Round emergency outlet made of PP with flange and factory-fitted EVALASTIC® connecting flange (light grey, slate grey matt),</p> <p>incl. wired domed leaf guard</p> <p>Pipe length 500 mm</p> <p>optional base plate for the connection to the vapor barrier see page 94</p> | DN 70 | 84.50 |
| | | DN 100 | 105.00 |
|  | <p>Water spout type SW EVALASTIC®</p> <p>Round emergency outlet made of PP with angled flange (production-related accumulation height approx. 5 mm) and factory-fitted EVALASTIC® connecting flange (light grey, slate grey matt),</p> <p>incl. wired domed leaf guard</p> <p>Pipe length 500 mm</p> <p>optional base plate for the connection to the vapor barrier see page 94</p> | DN 70 | 91.50 |
| | | DN 100 | 114.00 |





Accessories and spare parts rainwater outlets / emergency outlets

| | Product | Dimension | €/piece |
|---|---|------------------|-------------------|
|  | <p>Thermostat, with external outdoor temperature sensor, 230 V AC</p> <p>For energy-saving control of all heatable alwitra rainwater outlets, switching on and switching off threshold can be controlled separately, for the control of 1 up to 50 rainwater outlets at the same time, DIN rail mounting</p> | | 247.00 |
|  | <p>Screwing aid</p> <p>For secure installation of the screw ring of all alwitra rainwater outlets, extension elements and emergency outlet sockets</p> | | on request |
|  | <p>Bellows</p> <p>For the flexible connection of rainwater outlets S 125/110 or SH 125/110 to downpipes DN 125 (OD 125 mm), DN 100 (OD 110 mm) or DN 70 (OD 75 mm),</p> <p>e.g. in load carrying constructions made of trapezoidal sheet metal, incl. stainless steel bracket</p> | DN 125 to DN 125 | 66.50 |
| | | DN 125 to DN 100 | |
| | | DN 125 to DN 70 | |
|  | <p>Base plate/refurbishment plate</p> <p>As a pipe penetration and to connect a water spout or DN pipe to a vapor barrier, made of aluminium,</p> <p>OD approx. 320 mm, bendable on site,</p> <p>incl. lip ring</p> | DN 50 | 49.00 |
| | | DN 70 | 54.50 |
| | | DN 100 | 57.00 |
| | | DN 125 | 60.00 |



Accessories and spare parts rainwater outlets / emergency outlets

| | Product | Dimension | €/piece |
|---|---|------------------|---------|
|  | <p>Reducer 125/75, eccentric</p> <p>For the connection of rainwater outlets S 125/110 resp. SH 125/110 to downpipes DN 70 (OD 75 mm)</p> | DN 125 to DN 70 | 10.50 |
|  | <p>Adapter 125/160, eccentric</p> <p>For the connection of rainwater outlets S 125/110 resp. SH 125/110 to downpipes DN 150 (OD 160 mm)</p> | DN 125 to DN 150 | 24.50 |
|  | <p>Adapter 75/110, eccentric</p> <p>For the connection of rainwater outlets W 75/110 resp. WH 75/110 to pipes DN 100 (OD 110 mm), as a spare part</p> | DN 70 to DN 100 | 10.50 |
|  | <p>Reducer 125/110, eccentric</p> <p>For the connection of rainwater outlets S 125/110 resp. SH 125/110 to downpipes DN 100 (OD 110 mm), as a spare part</p> | DN 125 to DN 100 | 10.50 |

Accessories and spare parts rainwater outlets / emergency outlets

| | Product | Dimension | €/piece |
|---|---|-----------|--------------|
|  | <p>Leaf guard and gravel stop</p> <p>Fitting all alwitra rainwater outlets, extension elements and emergency outlet sockets, as a spare part</p> | | 8.00 |
|  | <p>Downpipe adapter</p> <p>DN 100 (OD 110 mm) to pipe ID ~100 mm for the backflow-proofed connection of pipes DN 100 (OD 110 mm) to vertical downpipes with an ID of 97 - 103 mm</p> | | 22.00 |
|  | <p>alwitra screw ring</p> <p>fitting all alwitra rainwater outlets and expansion elements, as a spare part</p> | | 6.00 |
|  | <p>Gasket oval</p> <p>For the backflow-proofed flashing of the connecting flange underneath the screw ring or emergency outlet socket of all alwitra rainwater outlets, extension elements and emergency outlet sockets, as a spare part</p> | | 4.00 |

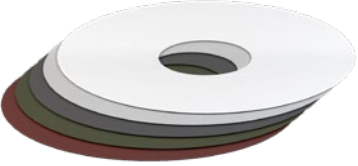
Accessories and spare parts rainwater outlets / emergency outlets

| | Product | Dimension | €/piece |
|---|---|-----------|--------------|
|  | <p>Rollring</p> <p>Fitting all alwitra rainwater outlets, for flashing to the extension elements, as a spare part</p> | | 4.00 |
|  | <p>Connecting flange</p> <p>Custom-fit for all alwitra rainwater outlets and expansion elements, OD 480 mm, thickness 1.5 mm</p> <p>for flashing to the roof waterproofing made of</p> | OD 480 mm | |
| | <p>EVALON® (white, light grey, slate grey, green, brick red)</p> | | 13.00 |
| | <p>EVALASTIC® (light grey, slate grey matt)</p> | | 13.00 |
|  | <p>Connecting flange bitumen</p> <p>Custom-fit for all alwitra rainwater outlets, OD 500 mm, thickness approx. 5 mm, for flashing against vapour barriers made of bitumen</p> | OD 500 mm | 22.00 |





Flat roof vents

Please also note our **new EVASTEEL vent stack** (see pages 80/81)

alwitra flat roof vents and accessories

| | Product | Dimension | €/piece |
|---|--|------------------|---------------|
|  | Vent stack 300 For flashing to downpipes DN 125 (OD 125 mm) incl. reducer to DN 100 (OD 110 mm), for thermal insulation thicknesses from 0 - 300 mm, with integrated connecting flange made of EVALON® or EVALASTIC® and removable vent cowl The necessary opening in the supporting structure is approx. Ø 190 - 200 mm for roof waterproofings made of | DN 125 to DN 100 | |
| | EVALON® (white, light grey, slate grey, green, brick red) | | 105.50 |
| | EVALASTIC® (light grey, slate grey matt) | | 105.50 |
| | Vent stack SL For flashing to downpipes DN 125 (OD 125 mm) incl. reducer to DN 100 (OD 110 mm), for thermal insulation thicknesses > 300 mm as special length according to customer specification, with integrated connecting flange made of EVALON® or EVALASTIC® and removable vent cowl The necessary opening in the supporting structure is approx. Ø 190 - 200 mm for roof waterproofings made of | DN 125 to DN 100 | |
| | EVALON® (white, light grey, slate grey, green, brick red) | | 143.50 |
| | EVALASTIC® (light grey, slate grey matt) | | 143.50 |
|  | Reducer 125/75, eccentric For flashing of the vent stack to downpipes DN 70 (OD 75 mm) | DN 125 to DN 70 | 10.50 |
|  | Bellows For the flexible connection of vent stacks DN 125 (OD 125 mm) to downpipes DN 125 (OD 125 mm), DN 100 (OD 110 mm) or DN 70 (OD 75 mm), e.g. in load carrying constructions made of trapezoidal sheet metal, incl. stainless steel bracket | DN 125 to DN 125 | 66.50 |
| | | DN 125 to DN 100 | |
| | | DN 125 to DN 70 | |
|  | Cold roof vent 125 Vent cross section ~ 110 cm² incl. condensate drip pan, removable vent cowl, weather cap and integrated connecting flange made of EVALON® or EVALASTIC® The necessary opening in the supporting structure is approx. Ø 150 mm for roof waterproofings made of | DN 125 | |
| | EVALON® (white, light grey, slate grey, green, brick red) | | 98.50 |
| | EVALASTIC® (light grey, slate grey matt) | | 98.50 |

alwitra flat roof vents and accessories

| | Product | Dimension | €/piece |
|---|--|-----------|-------------|
|  | <p>Weather cap</p> <p>For the rain-proof upper finish of the vent stack / cold roof vent</p> | | 8.00 |
|  | <p>Vent cowl for vent stack and cold roof vent</p> <p>Vent cowl made of PP, as a spare part</p> | | 8.00 |

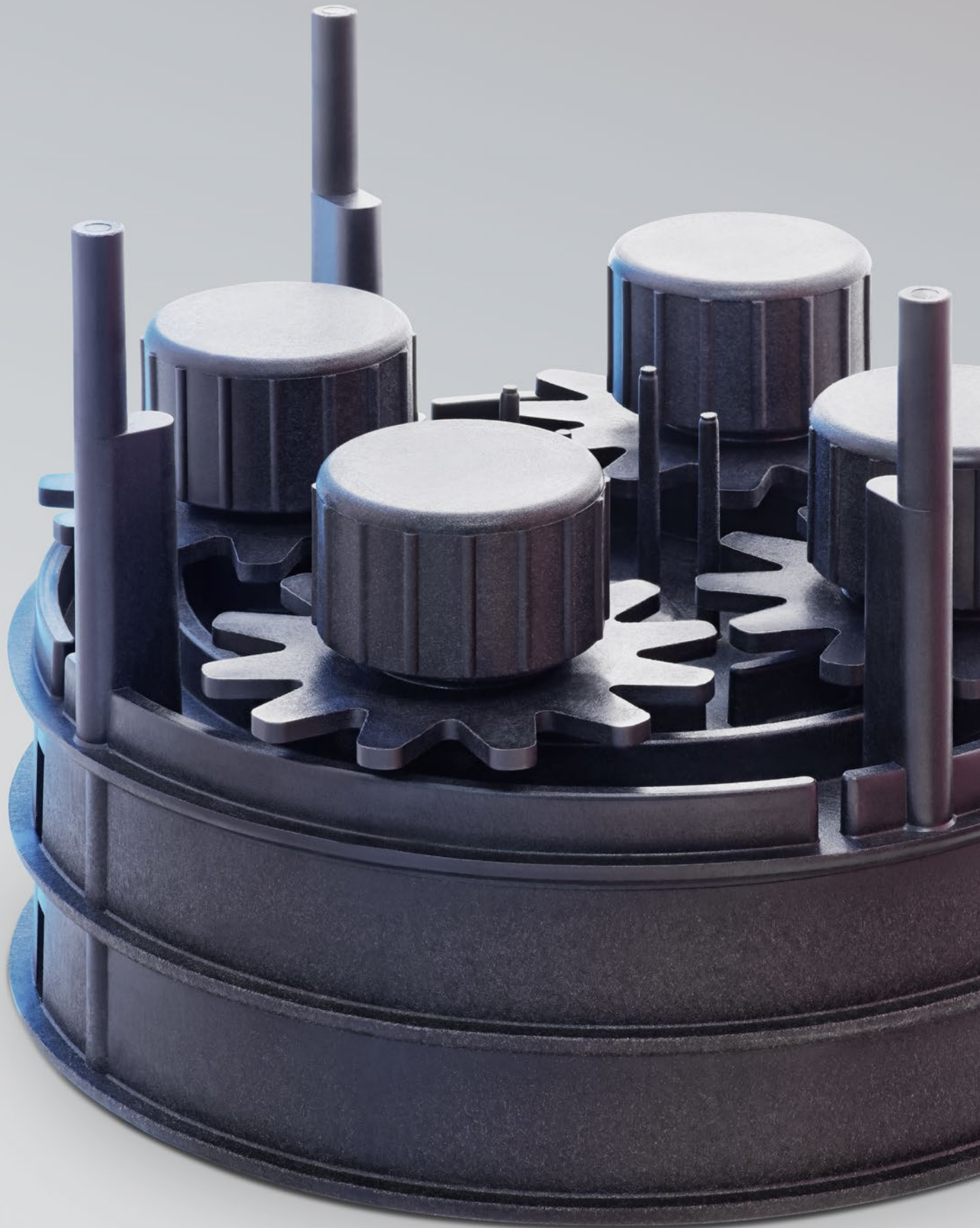

Paving slab supports



Paving slab support type PA 20 plus with gap cross

| Product specification | Packing unit (PU) | | Requirement ¹ | | €/piece |
|--|-------------------|--------------|--|--|-------------|
| | Piece/carton | Piece/pallet | Piece/m ² at paving size 40 / 40 / 4 cm | Piece/m ² at paving size 50 / 50 / 4 (5) cm | |
| patent-registered, back-tracking lock, height adjustment, made of weather and temperature resistant polyamide | 24 | 1,440 | approx. 6.3 | approx. 4 | 4.90 |

Paving slab support type PA 20 plus with gap cross

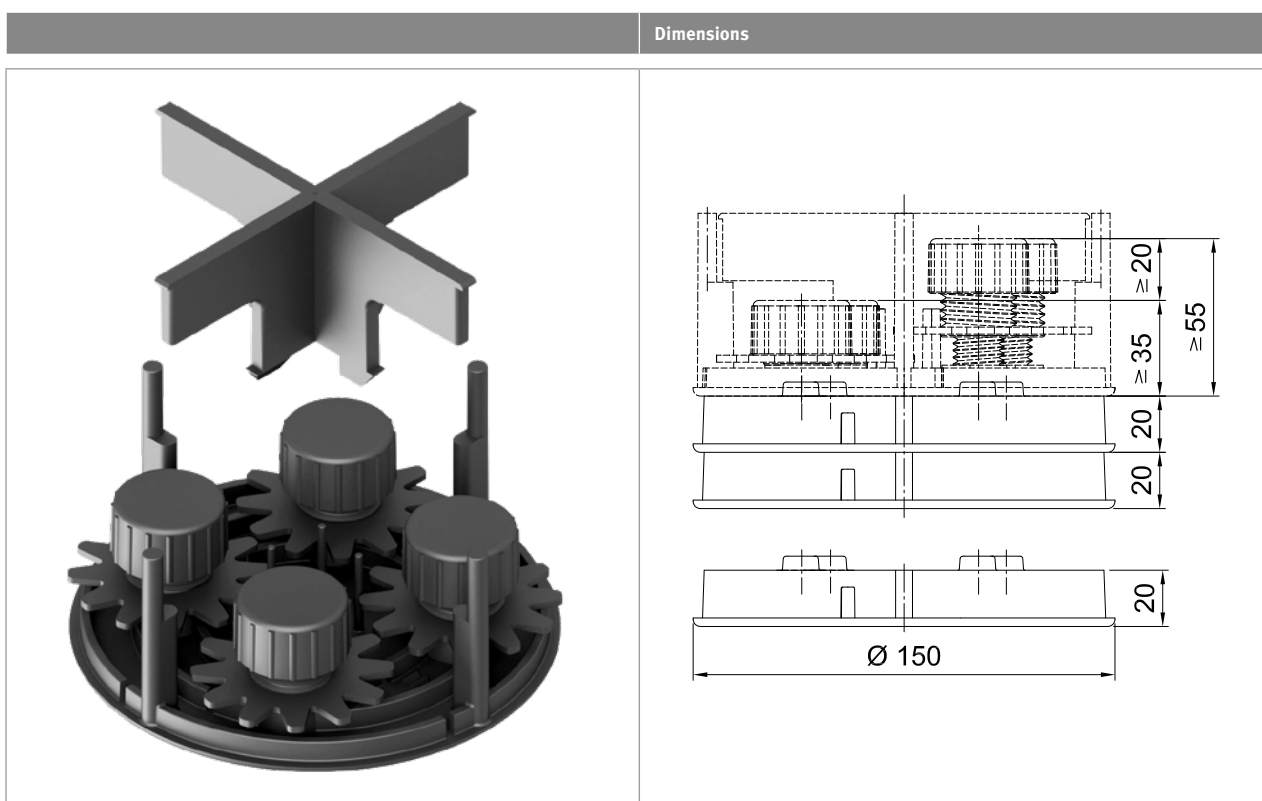

Technical data

| Base area | Installation ² | Height adjustment | Load capacity | Drainage gaps (gap width) | Temperature resistance | Material |
|---------------------|---------------------------|-------------------------|-------------------------|---------------------------|------------------------|---------------------------|
| 175 cm ² | on protection layer | from 35 - 55 mm (20 mm) | 4 x 2 kN/paving support | 6 mm | from -30 °C to +100 °C | plastics PP-H GF30, black |

¹ Additional requirements by using of complete paving supports and pared paving at the paving edges has to be noted

² With safety device of the paving against lateral movement at the terrace edge

Shim

Shim 20 mm for paving slab supports, type PA 20 plus with gap cross

| Product specification | Packing unit (PU) | | Requirement | €/piece |
|---|-------------------|--------------|--|-------------|
| | Piece/carton | Piece/pallet | | |
| stackable, made of weather and temperature resistant polyamide | 48 | 2,880 | Assessment of demand see table on next page | 1.55 |

Shim 20 mm for paving slab supports, type PA 20 plus with gap cross

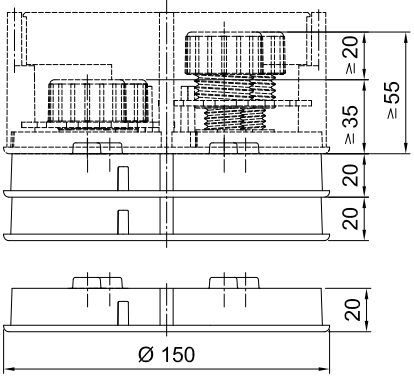
| | Dimensions | Quantity of shims | Height in mm |
|--|------------|-------------------|--------------|
| | | without | 35 - 55 |
|   | | 1 | 55 - 75 |
| | | 2 | 75 - 95 |
| | | 3 | 95 - 115 |
| | | 4 | 115 - 135 |
| | | 5 | 135 - 155 |
| | | 6 | 155 - 175 |
| | | 7 | 175 - 195 |

Technical data

| Base area | Installation ^{1,2} | Height adjustment | Load capacity | Temperature resistance | Material |
|---------------------|-----------------------------|-------------------|---------------|---------------------------|------------------------------|
| 175 cm ² | on protection layer | from 20 mm | 8 kN/shim | from -30 °C to +100 °C | plastics PP-H GF30, black |

¹ With safety device of the pavings against lateral movement at the terrace edge

² Max. 7 shims below one paving support

Calculation of the required shims

Calculation of the required shims for PA 20 plus in case of slope differences between bottom and pavings.

Slope difference waterproofing membrane - pavings 1 %

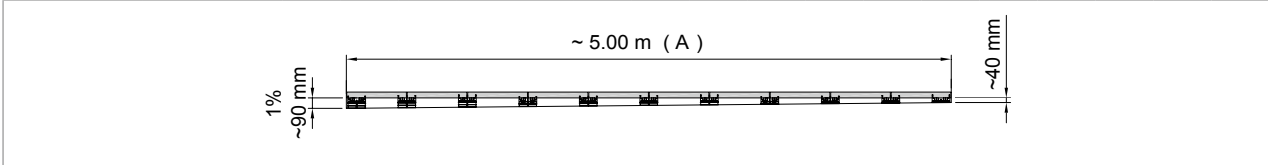

| Paving size 50 x 50 cm | | Length B [m] | | | | | | | | | | | | | | | | |
|------------------------|---------------|--------------|------|------|------|------|------|------|------|------|------|------|------|------|------|------|------|-------|
| Slope length A [m] | Shims/line up | 2.00 | 2.50 | 3.00 | 3.50 | 4.00 | 4.50 | 5.00 | 5.50 | 6.00 | 6.50 | 7.00 | 7.50 | 8.00 | 8.50 | 9.00 | 9.50 | 10.00 |
| up to 1.50 m | 0 | 0 | 0 | 0 | 0 | 0 | 0 | 0 | 0 | 0 | 0 | 0 | 0 | 0 | 0 | 0 | 0 | 0 |
| 2.00 | 1 | 5 | 6 | 7 | 8 | 9 | 10 | 11 | 12 | 13 | 14 | 15 | 16 | 17 | 18 | 19 | 20 | 21 |
| 2.50 | 2 | 10 | 12 | 14 | 16 | 18 | 20 | 22 | 24 | 26 | 28 | 30 | 32 | 34 | 36 | 38 | 40 | 42 |
| 3.00 | 3 | 15 | 18 | 21 | 24 | 27 | 30 | 33 | 36 | 39 | 42 | 45 | 48 | 51 | 54 | 57 | 60 | 63 |
| 3.50 | 4 | 20 | 24 | 28 | 32 | 36 | 40 | 44 | 48 | 52 | 56 | 60 | 64 | 68 | 72 | 76 | 80 | 84 |
| 4.00 | 6 | 30 | 36 | 42 | 48 | 54 | 60 | 66 | 72 | 78 | 84 | 90 | 96 | 102 | 108 | 114 | 120 | 126 |
| 4.50 | 8 | 40 | 48 | 56 | 64 | 72 | 80 | 88 | 96 | 104 | 112 | 120 | 128 | 136 | 144 | 152 | 160 | 168 |
| 5.00 | 10 | 50 | 60 | 70 | 80 | 90 | 100 | 110 | 120 | 130 | 140 | 150 | 160 | 170 | 180 | 190 | 200 | 210 |

1 % = 10 mm height difference/m Quantity of shims

Slope difference waterproofing membrane - pavings 2 %

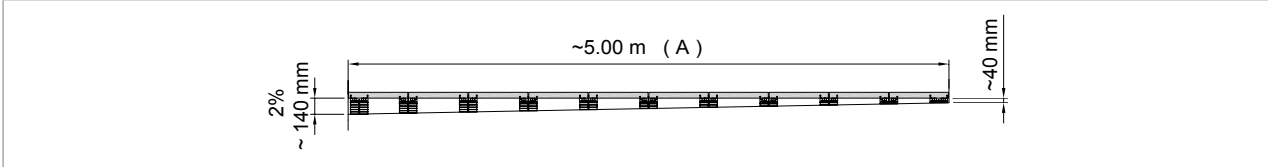

| Paving size 50 x 50 cm | | Length B [m] | | | | | | | | | | | | | | | | |
|------------------------|---------------|--------------|------|------|------|------|------|------|------|------|------|------|------|------|------|------|------|-------|
| Slope length A [m] | Shims/line up | 2.00 | 2.50 | 3.00 | 3.50 | 4.00 | 4.50 | 5.00 | 5.50 | 6.00 | 6.50 | 7.00 | 7.50 | 8.00 | 8.50 | 9.00 | 9.50 | 10.00 |
| up to 0.50 m | 0 | 0 | 0 | 0 | 0 | 0 | 0 | 0 | 0 | 0 | 0 | 0 | 0 | 0 | 0 | 0 | 0 | 0 |
| 1.00 | 1 | 5 | 6 | 7 | 8 | 9 | 10 | 11 | 12 | 13 | 14 | 15 | 16 | 17 | 18 | 19 | 20 | 21 |
| 1.50 | 2 | 10 | 12 | 14 | 16 | 18 | 20 | 22 | 24 | 26 | 28 | 30 | 32 | 34 | 36 | 38 | 40 | 42 |
| 2.00 | 4 | 20 | 24 | 28 | 32 | 36 | 40 | 44 | 48 | 52 | 56 | 60 | 64 | 68 | 72 | 76 | 80 | 84 |
| 2.50 | 6 | 30 | 36 | 42 | 48 | 54 | 60 | 66 | 72 | 78 | 84 | 90 | 96 | 102 | 108 | 114 | 120 | 126 |
| 3.00 | 9 | 45 | 54 | 63 | 72 | 81 | 90 | 99 | 108 | 117 | 126 | 135 | 144 | 153 | 162 | 171 | 180 | 189 |
| 3.50 | 12 | 60 | 72 | 84 | 96 | 108 | 120 | 132 | 144 | 156 | 168 | 180 | 192 | 204 | 216 | 228 | 240 | 252 |
| 4.00 | 16 | 80 | 96 | 112 | 128 | 144 | 160 | 176 | 192 | 208 | 224 | 240 | 256 | 272 | 288 | 304 | 320 | 336 |
| 4.50 | 20 | 100 | 120 | 140 | 160 | 180 | 200 | 220 | 240 | 260 | 280 | 300 | 320 | 340 | 360 | 380 | 400 | 420 |
| 5.00 | 25 | 125 | 150 | 175 | 200 | 225 | 250 | 275 | 300 | 325 | 350 | 375 | 400 | 425 | 450 | 475 | 500 | 525 |

2 % = 20 mm height difference/m Quantity of shims

Calculation of the required shims

Slope difference waterproofing membrane - pavings 3 %

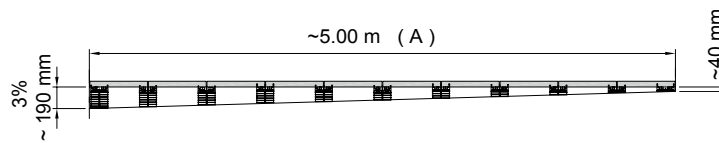

| Paving size 50 x 50 cm | | Length B [m] | | | | | | | | | | | | | | | | |
|------------------------|---------------|--------------|------|------|------|------|------|------|------|------|------|------|------|------|------|------|------|-------|
| Slope length A [m] | Shims/line up | 2.00 | 2.50 | 3.00 | 3.50 | 4.00 | 4.50 | 5.00 | 5.50 | 6.00 | 6.50 | 7.00 | 7.50 | 8.00 | 8.50 | 9.00 | 9.50 | 10.00 |
| up to 0.50 m | 0 | 0 | 0 | 0 | 0 | 0 | 0 | 0 | 0 | 0 | 0 | 0 | 0 | 0 | 0 | 0 | 0 | 0 |
| 1.00 | 1 | 5 | 6 | 7 | 8 | 9 | 10 | 11 | 12 | 13 | 14 | 15 | 16 | 17 | 18 | 19 | 20 | 21 |
| 1.50 | 3 | 15 | 18 | 21 | 24 | 27 | 30 | 33 | 36 | 39 | 42 | 45 | 48 | 51 | 54 | 57 | 60 | 63 |
| 2.00 | 6 | 30 | 36 | 42 | 48 | 54 | 60 | 66 | 72 | 78 | 84 | 90 | 96 | 102 | 108 | 114 | 120 | 126 |
| 2.50 | 9 | 45 | 54 | 63 | 72 | 81 | 90 | 99 | 108 | 117 | 126 | 135 | 144 | 153 | 162 | 171 | 180 | 189 |
| 3.00 | 13 | 65 | 78 | 91 | 104 | 117 | 130 | 143 | 156 | 169 | 182 | 195 | 208 | 221 | 234 | 247 | 260 | 273 |
| 3.50 | 18 | 90 | 108 | 126 | 144 | 162 | 180 | 198 | 216 | 234 | 252 | 270 | 288 | 306 | 324 | 342 | 360 | 378 |
| 4.00 | 24 | 120 | 144 | 168 | 192 | 216 | 240 | 264 | 288 | 312 | 336 | 360 | 384 | 408 | 432 | 456 | 480 | 504 |
| 4.50 | 30 | 150 | 180 | 210 | 240 | 270 | 300 | 330 | 360 | 390 | 420 | 450 | 480 | 510 | 540 | 570 | 600 | 630 |
| 5.00 | 37 | 185 | 222 | 259 | 296 | 333 | 370 | 407 | 444 | 481 | 518 | 555 | 592 | 629 | 666 | 703 | 740 | 777 |

3 % = 30 mm height difference/m

Quantity of shims

Packing units EVALON®

EVALON® waterproofing membrane, standard length 25 m

| Product | Width m | m ² /roll | kg/roll nominal thickness | | Rolls/pallet * | Approx. kg/pallet gross | |
|------------------------------|------------|----------------------|------------------------------|------------|----------------|----------------------------|--------------|
| | | | 1.2 mm | 1.5 mm | | 1.2 mm | 1.5 mm |
| EVALON® (unbacked) | 1.05 | 26.25 | 41 | 51 | 15 | 635 | 785 |
| | 1.55 | 38.75 | 61 | 76 | 15 | 940 | 1,165 |
| | 2.00 | 50.00 | 79 | 98 | 15 | 1,215 | 1,500 |
| EVALON® V | 1.05 | 26.25 | 44 | 54 | 10 | 460 | 585 |
| | 1.55 | 38.75 | 65 | 80 | 10 | 675 | 825 |
| | 2.05 | 51.25 | 86 | 106 | 10 | 890 | 1,090 |
| | 1.09 | 27.25 | 46 | 56 | 10 | 480 | 580 |
| | 1.59 | 39.75 | 67 | 82 | 10 | 695 | 845 |
| EVALON® VG | 1.05 | 26.25 | | 55 | 10 | | 570 |
| | 1.55 | 38.75 | | 81 | 10 | | 835 |
| | 1.09 | 27.25 | | 57 | 10 | | 590 |
| | 1.59 | 39.75 | | 83 | 10 | | 855 |
| EVALON® VSK | 1.05 | 26.25 | 50 | 59 | 10 | 520 | 610 |
| EVALON® VGSK | 1.05 | 26.25 | | 60 | 10 | | 620 |

* For orders in other units, we calculate a surcharge of 20.00 € per pallet

Packing units EVALON®

EVALON® prefabricated parts / standing seam effect profile and accessories

| Product | Pieces/carton |
|--|---------------------------|
| Internal corner type W | 140 |
| External corner type W | 130 |
| Internal corner TA/TAG | 200 |
| External corner TA/TAG | 200 |
| Standing seam effect profile | 50 (= 100 m) |
| alwitra solvent welding agent | tin at 3.0 l 12 |
| liquid EVALON® white/light grey/slate grey | tin at 2.5 l 4 |

Adhesives / cleaner / primer

| Product | Quantity | Packing unit / pallet |
|--|-----------------|---|
| alwitra adhesive L 40 | 25 kg 9.5 kg | 12 containers 30 containers |
| alwitra adhesive PUR S750 | 750 ml | 12 tins only full packing units at 12 tins/carton |
| alwitra membrane cleaner <i>not suitable for cleaning of the seam area!</i> | 2 kg | |
| alwitra cleaner L 40 (tool cleaner) | 10 l | |
| alwitra primer SK-L for EVALON® VSK, EVALON® VGSK and EVALON® VSKA | 25 l 10 l | 12 pieces 42 pieces |
| alwitra primer SK¹ for EVALON® VSK, EVALON® VGSK and EVALON® VSKA | 25 l 10 l | 12 pieces 44 pieces |

¹ solvent free

Packing units EVALASTIC®

EVALASTIC® waterproofing membrane, standard length 25 m

| Product | Width | m ² /roll | kg/roll nominal thickness | | Rolls/pallet * | Approx. kg/pallet gross | |
|---------------------------------|-------|----------------------|---------------------------|-----------|----------------|-------------------------|--------------|
| | | | 1.2 mm | 1.5 mm | | 1.2 mm | 1.5 mm |
| EVALASTIC® (unbacked) | 1.05 | 26.25 | | 49 | 15 | | 755 |
| | 1.55 | 38.75 | | 72 | 15 | | 1,100 |
| EVALASTIC® V | 1.05 | 26.25 | 43 | 52 | 10 | 450 | 540 |
| | 1.55 | 38.75 | 63 | 77 | 10 | 650 | 790 |
| | 1.09 | 27.25 | | 54 | 10 | | 560 |
| | 1.59 | 39.75 | | 79 | 10 | | 810 |
| EVALASTIC® VG | 1.05 | 26.25 | | 54 | 10 | | 560 |
| | 1.55 | 38.75 | | 79 | 10 | | 810 |
| EVALASTIC® VGSK | 1.05 | 26.25 | | 58 | 10 | | 600 |

* For orders in other units, we calculate a surcharge of 20.00 € per pallet

Packing units EVALASTIC®

EVALASTIC® prefabricated parts

| Product | Pieces/carton |
|-------------------------------------|---------------------|
| Internal corner type W | 200 |
| External corner type W | 200 |
| Standing seam effect profile | 50 (= 100 m) |

Adhesives / cleaner / primer

| Product | Quantity | Packing unit / pallet |
|---|-----------------|---|
| alwitra adhesive L 40 | 25 kg 9.5 kg | 12 containers 30 containers |
| alwitra adhesive PUR S750 | 750 ml | 12 tins only full packing units at 12 tins/carton |
| alwitra membrane cleaner not suitable for cleaning of the seam area! | 2 kg | |
| alwitra cleaner L 40 (tool cleaner) | 10 l | |
| alwitra primer SK-L for EVALASTIC® VGSK and EVALASTIC® VSKA | 25 l 10 l | 12 pieces 42 pieces |
| alwitra primer SK¹ for EVALASTIC® VGSK and EVALASTIC® VSKA | 25 l 10 l | 12 pieces 44 pieces |

¹ solvent free

Information and additional delivery conditions

1. Storability

Some of our products have a limited storability. Please take care of the imprints on the containers.

2. Redemption of goods

For redemption of goods (after reconciliation only) we are invoicing storage and freight charges.

3. Fastener

Delivery content is generally without fasteners.

4. Special corners / roundings

- Prices for non rectangle corners and/or of standard corners deviant leg lengths on request.
- Prices for roundings on request.

5. Special lengths and fitting pieces for aluminium profiles

For delivery

- of ready-to-fit pieces in lengths, which are different to the standard lengths (= special lengths) and
- of pieces in lengths, which are different to the standard lengths and which have to be cutted on site into the needed lengths (fitting piece) a surcharge of 20 % of the price per m will be invoiced additionally. The additional demand for brackets and accessories due to special lengths supplied ex factory is included in this surcharge.

6. Corner leg lengths MAG / MAK

Up to 300 mm crown width the corner leg lengths of the profiles are 50 cm / 50 cm.

Over 300 mm crown width they are = crown width + 20 cm.

7. Aluminium untreated (mill finish)

Mill finished aluminium profiles delivered by alwitra are untreated and must be stored dry and weather protected. Water spots and corrosion can lead to irreparable damages by incorrect storage (e.g. by not opening the transport packaging). For mill finished profiles toolmarks such as light grooves, cords and fingerprints are admissible and do not constitute any defect. For a decorative surface we recommend a colour coating.

8. Colour Coating (CC)

The colour categories „alwitra select“ and „alwitra select plus“ (for further information see www.alwitra.de/en/aluminium-profiles/synthetic-coatings) is characterized by a highly weatherproof powder quality (HWP, GSB-Master).

The billing of this colour category will be done according to the valid price list. The minimum coating values per colour and delivery are:

- **alwitra select:** minimum lump-sum for CC: 150.00 € gross.
- **alwitra select plus:** The billing will be done according to the valid price list for the colour category „alwitra select“ plus a surcharge of 25 %. The minimum lump-sum for colour coating amounts 550.00 € gross.
- **Other colours RAL CLASSIC:** All other colours of the RAL CLASSIC colour range are generally available only in the facade quality "GSB Standard" (not highly weatherproof). The billing will be done according to the valid price list for the colour category „alwitra select“ plus a surcharge of 10 %. The minimum coating value for other colours of the RAL CLASSIC colour range amounts: 300.00 € gross. Not available are e.g. fluorescent colours (RAL 1026, 2005, 2007, 3024, 3026).
- **Special colours,** that deviate from the RAL CLASSIC colour range, are – if deliverable – carried out by alwitra solely after a project-related testing and approval at extra cost.

9. Cleaning and care

Coloured surfaces generally meet highly decorative requirements, also in the long run. Subject to the particular conditions of strain a scheduled cleaning and care is required at least once a year. In case of intense environmental impacts this needs to be done more often.



#unitedontop

The product dimensions named in this price list are nominal dimensions without declaration of permissible product specific tolerances. Furthermore this price list applies only in combination with the published and currently valid product documentations and manufacturer's guidelines. All prices are without VAT. All previous price lists are void.

General Terms of Delivery apply as agreed!

(<https://alwitra.de/en/general-terms-and-conditions-of-delivery>)

The information, technical details or installation instructions contained in this document have been compiled to the best of our knowledge and were considered correct at the time of publication. alwitra is committed to continuous improvement and therefore reserves the right to change or supplement the product specifications without prior notice, in particular if necessitated by changes in the law. No rights can be derived from this document. Subject to changes and typographical/printing errors.

This version replaces all earlier versions. To obtain the latest version of this document, scan the QR code or use this link:

www.alwitra.de/en/downloads



Version 1. 07/2024

alwitra GmbH

54229 Trier · Germany · Phone: +49 651 9102-0

export@alwitra.de · www.alwitra.de